

AKEO

CATÁLOGO Linha Alumínio

2024

CATÁLOGO
Linha Alumínio

ACESSÓRIOS

- PUXADORES ALÇA;
- PUXADORES DE TOPO;
- PERFIS PUXADORES;
- PÉS;
- ACABAMENTOS.

OO
WE
KE
A

OO
EE
KE
AK
AK

PUXADORES

ALÇA



ALLURE

Alça: 96mm a 704mm

Acabamentos: Anodizado Natural, Anodizado Champagne e Black Epóxi.

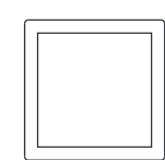
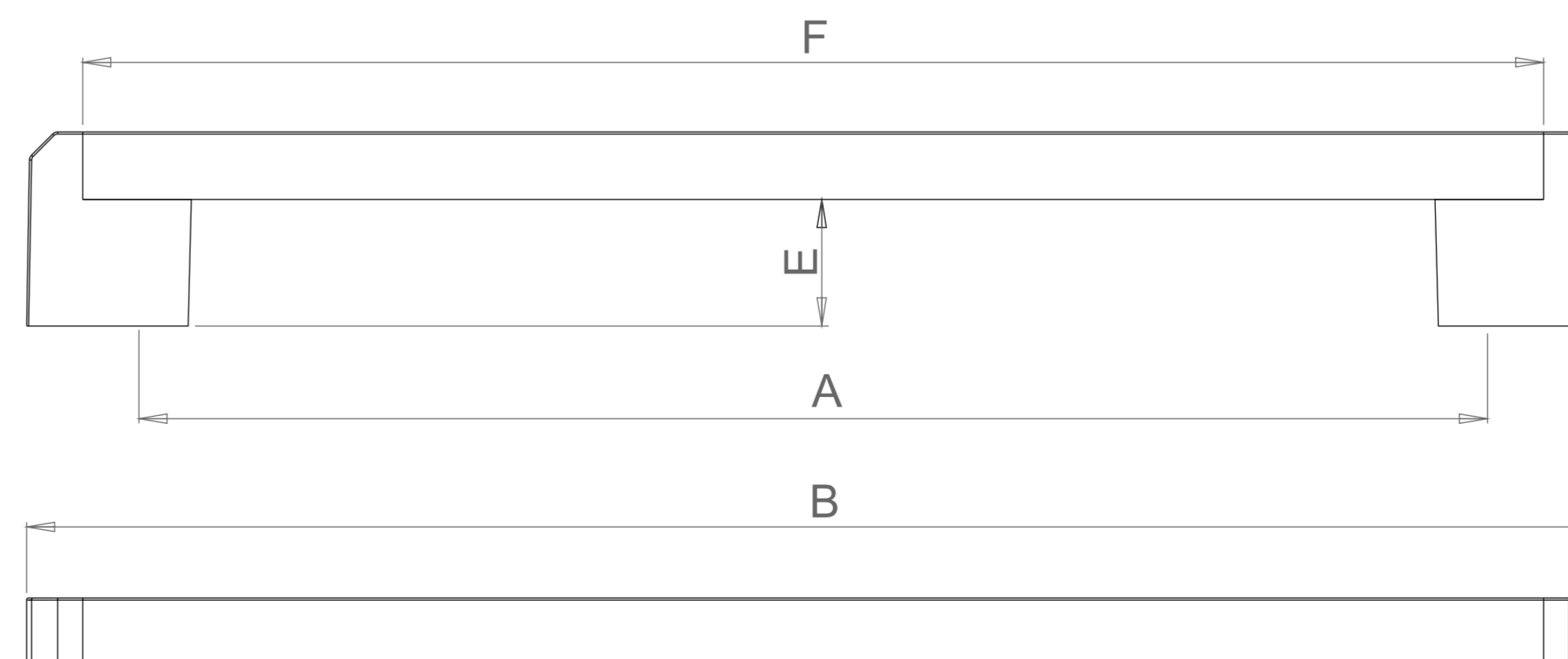
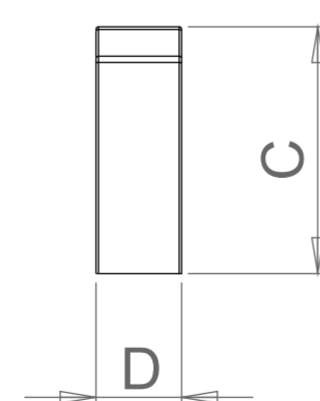
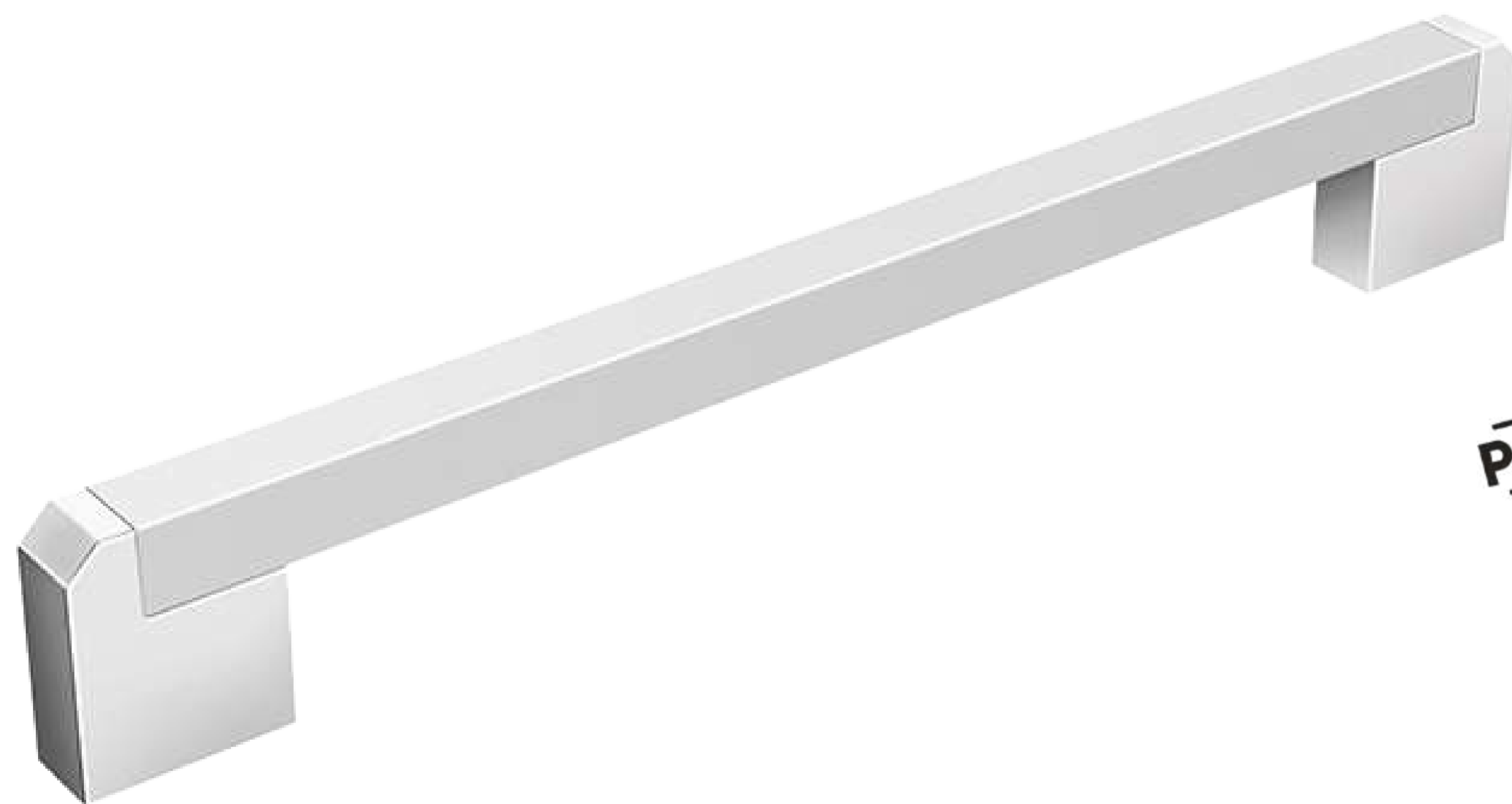

PERFIL

Código	A	B	C	D	E	F	Chapa
50770	192	224	28	10	18	208	15 / 18mm

*DIMENSÕES EM MILÍMETROS (mm) / IMAGENS E ACABAMENTOS MERAMENTE ILUSTRATIVOS.

akeo.com.br

ATHOS HAUT

Alça: 96mm a 704mm

Acabamentos: Anodizado Natural, Anodizado Champagne e Black Epóxi.



DICA AKEO!

Combine com: Puxador Athos Bas e Puxador Athos Courbe.



PERFIL

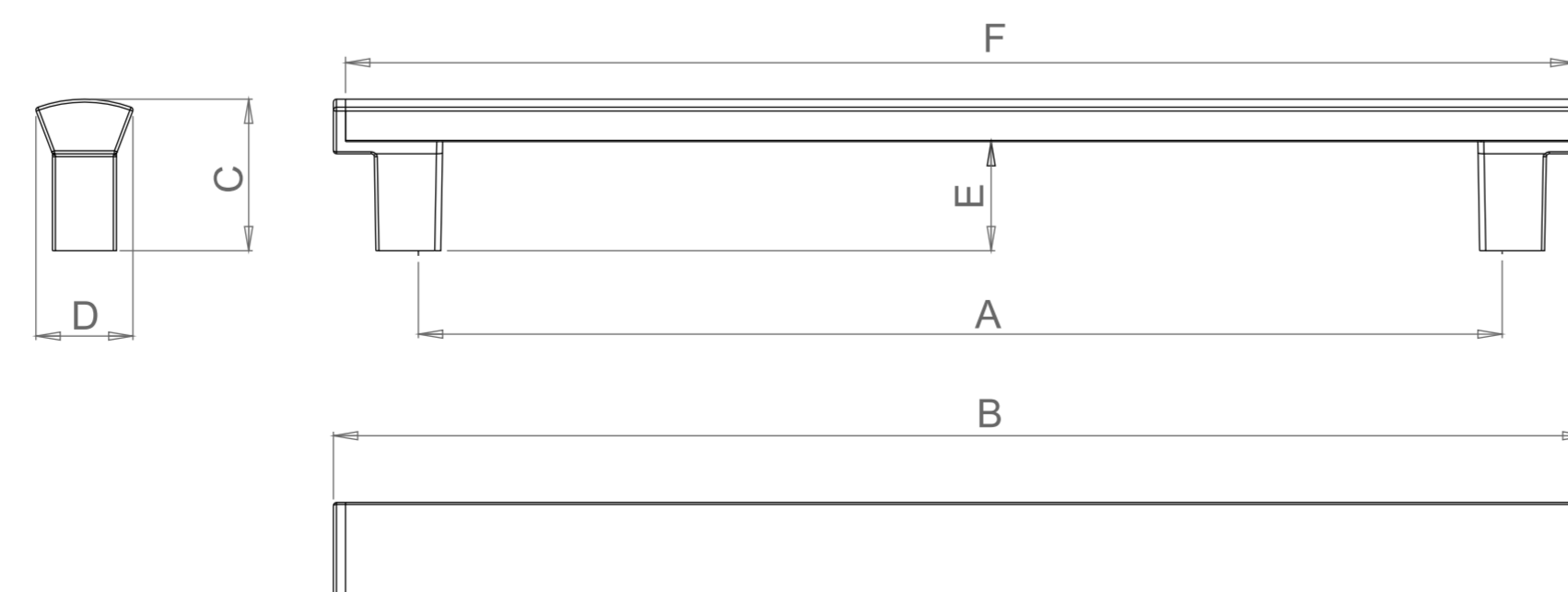

Código	A	B	C	D	E	F	Chapa
50129	160	188	25	16	18	184	15 / 18mm

*DIMENSÕES EM MILÍMETROS (mm) / IMAGENS E ACABAMENTOS MERAMENTE ILUSTRATIVOS.

akeo.com.br



ATHOS COURBE

Alça: 416mm a 928mm

Acabamentos: Anodizado Natural, Anodizado Champagne e Black Epóxi.

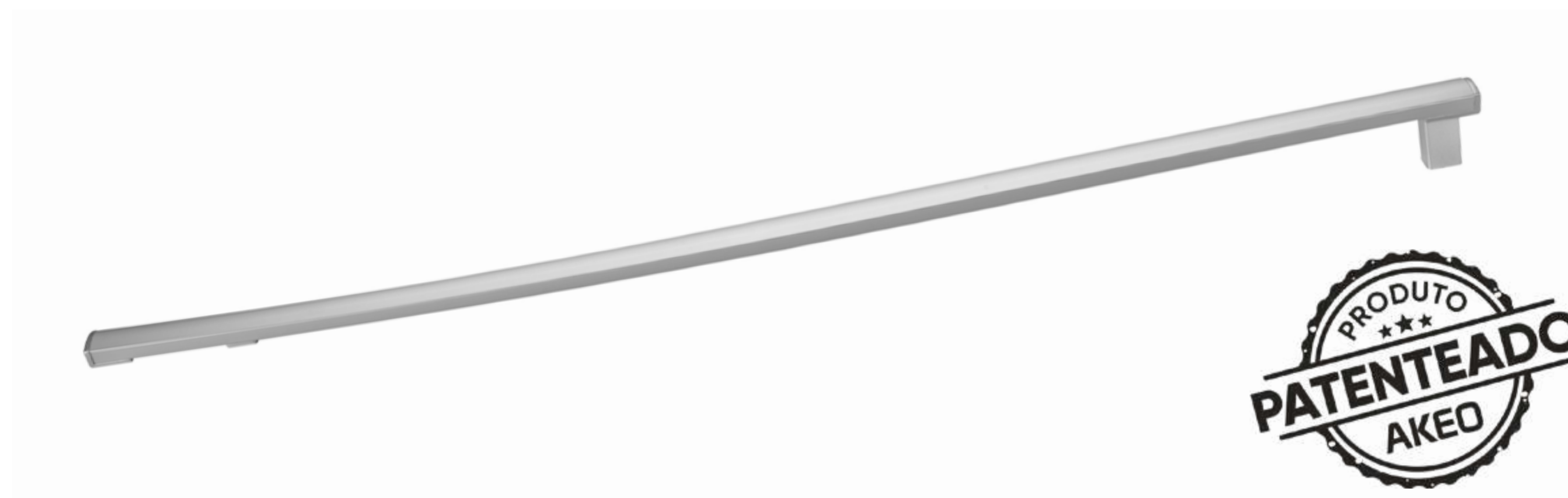

DICA AKEO!

Combine com: Puxador Athos Bas e Puxador Athos Haut.



PERFIL

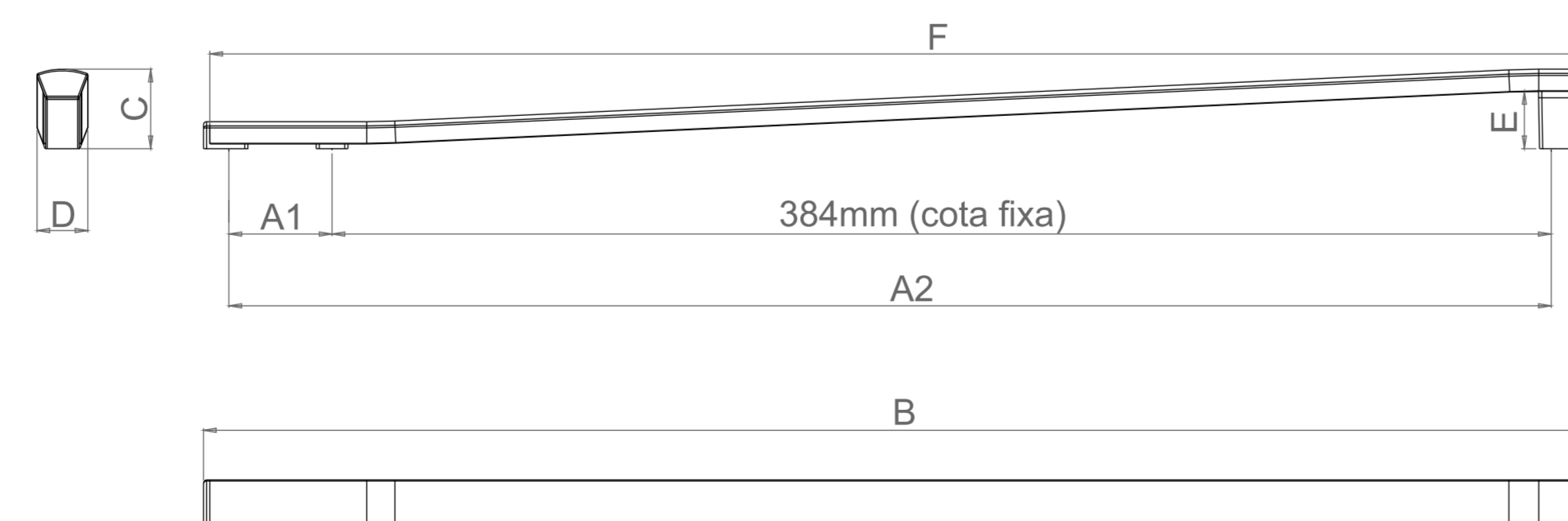

Código	A1	A2	B	C	D	E	F	Chapa
50130	32	416	440	25	16	18	435	15 / 18mm

*DIMENSÕES EM MILÍMETROS (mm) / IMAGENS E ACABAMENTOS MERAMENTE ILUSTRATIVOS.

akeo.com.br



ATHOS BAS

Perfil Puxador: 64mm a 992mm

Acabamentos: Anodizado Natural, Anodizado Champagne e Black Epóxi.



DICA AKEO!

Combine com: Puxador Athos Haut e Puxador Athos Courbe.



PERFIL

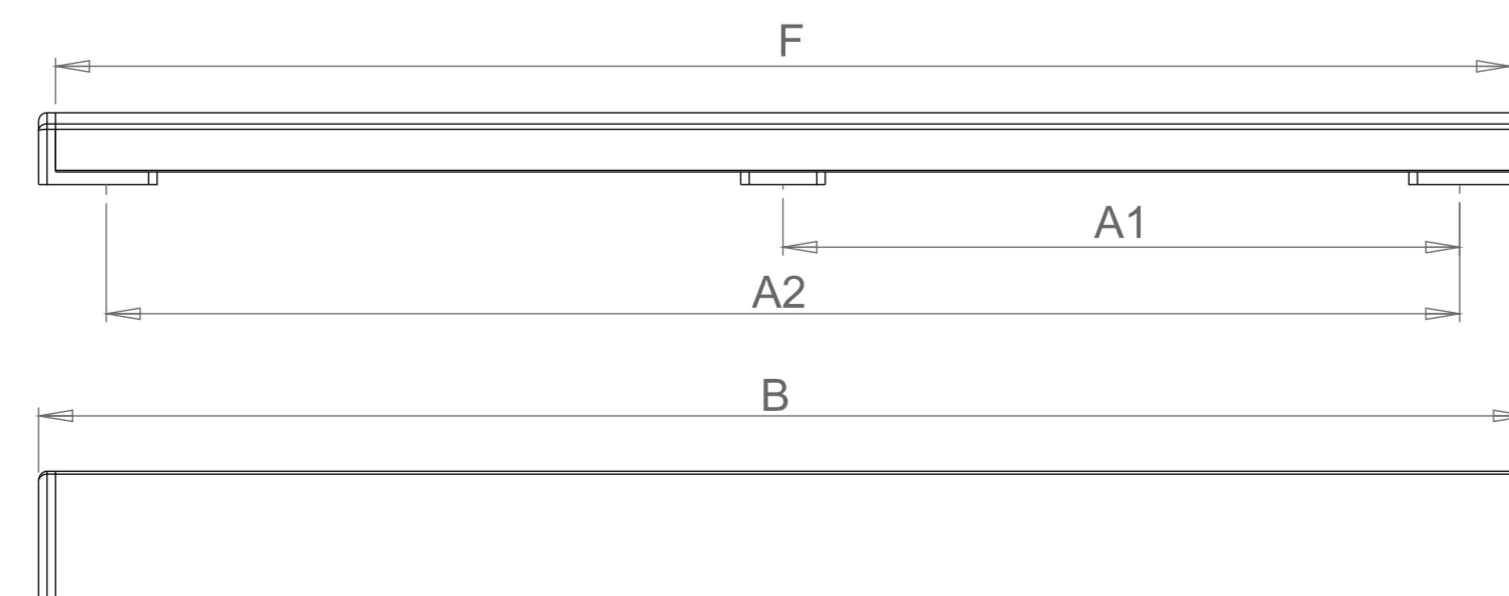
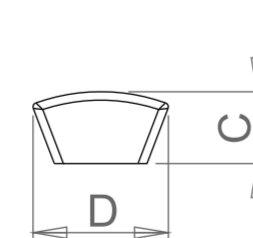

Código	A1	A2	B	C	D	E	F	Chapa
50131	80	160	176	9	16	-	172	15 / 18mm

*DIMENSÕES EM MILÍMETROS (mm) / IMAGENS E ACABAMENTOS MERAMENTE ILUSTRATIVOS.



PUX. ATHOS BAS
ANOD. CHAMPAGNE

PUX. ATHOS HAUT
ANOD. CHAMPAGNE

PUX. ATHOS COURBE
ANOD. CHAMPAGNE

FAMÍLIA ATHOS

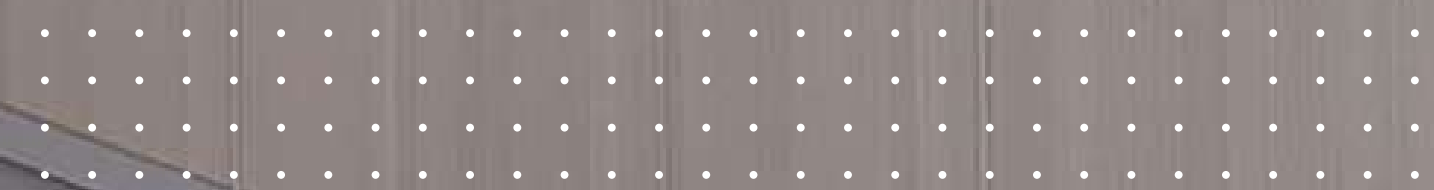

LANÇAMENTO
Alumínio

CARMEM

Alça:

Acabamentos: Sob consulta.

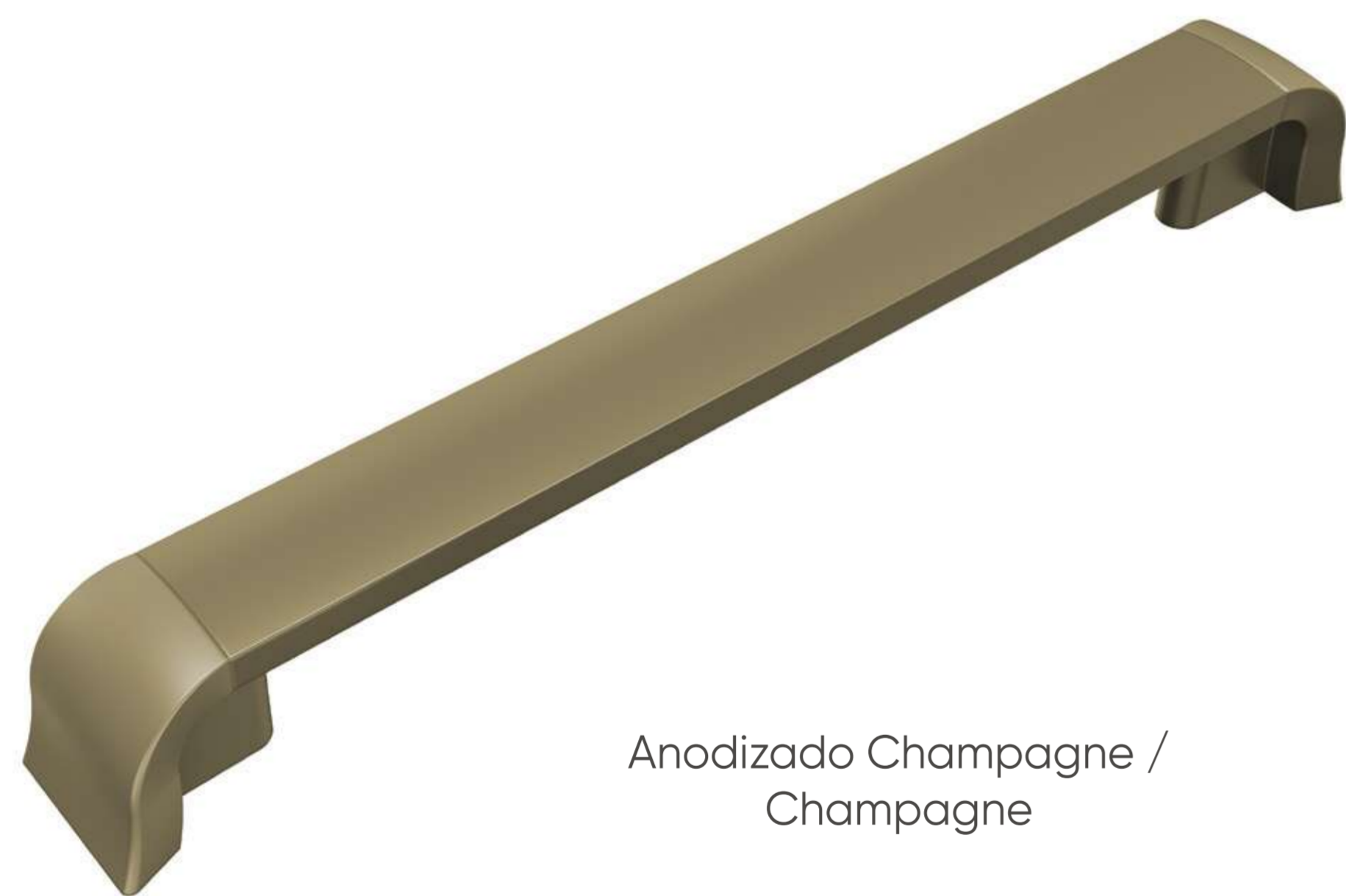

Anodizado Champagne /
Champagne

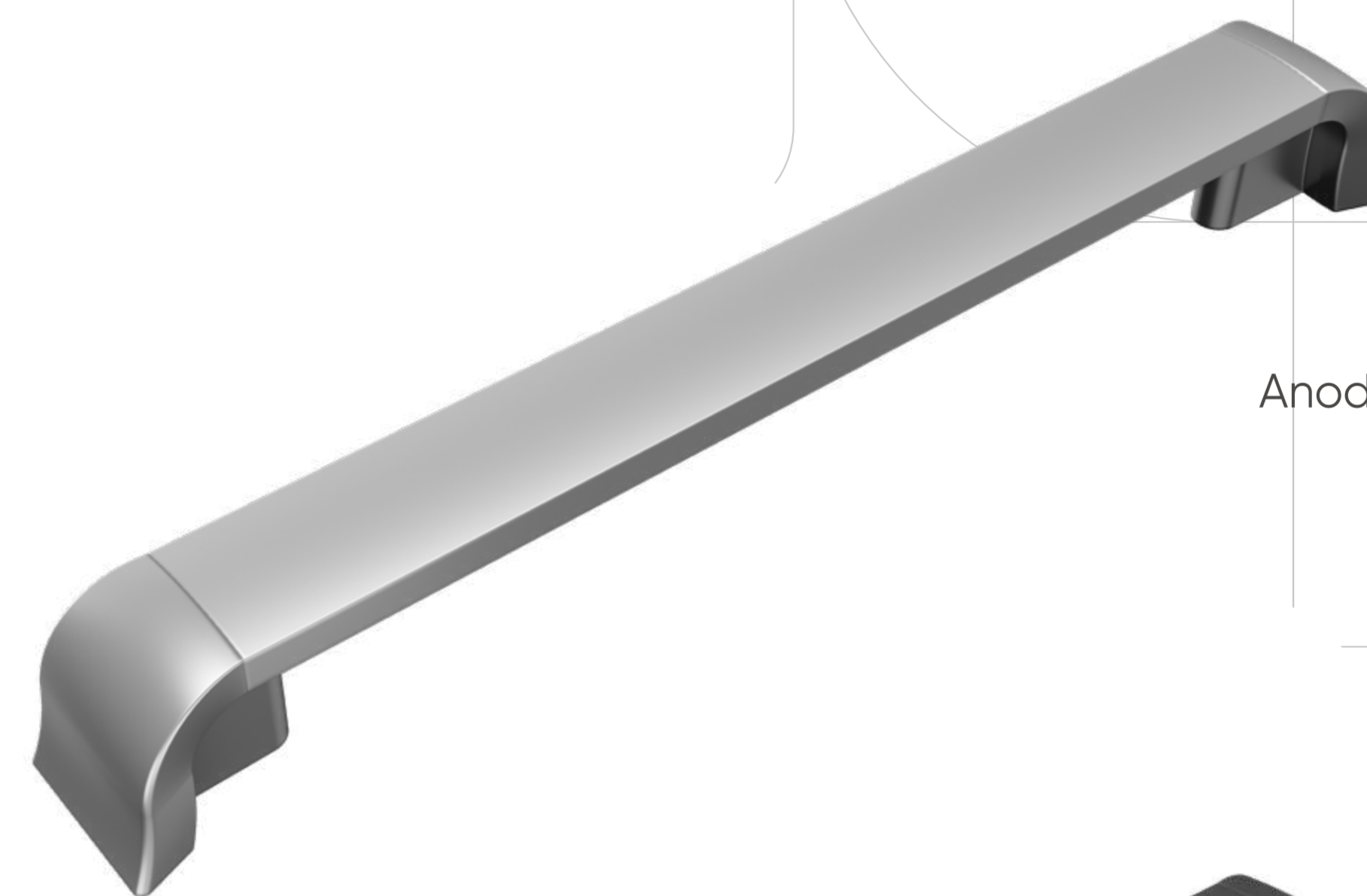

Anodizado Natural /
Prata



Black Epóxi /
Black

*DIMENSÕES EM MILÍMETROS (mm) / IMAGENS E ACABAMENTOS MERAMENTE ILUSTRATIVOS.

akeo.com.br

LANÇAMENTO
Alumínio

CARTER

Alça: 128mm a 704mm



DICA AKEO!

Combine com:
Puxador Nimbus



Anodizado Natural
/ Prata

Anodizado Champagne
/ Champagne

Black Epóxi
/ Black

Consulte
outras opções
de acabamento.



*DIMENSÕES EM MILÍMETROS (mm) / IMAGENS E ACABAMENTOS MERAMENTE ILUSTRATIVOS.

PUX. CARTER

VÍDEO
AKEO

MAIS INFORMAÇÕES
SOBRE O PRODUTO
ACESSE O QR CODE



PUX. NIMBUS
CHAMPAGNE

PUX. CARTER
ANOD. CHAMPAGNE

PUX. CARTER



PUX. CARTER
ANODIZADO CHAMPAGNE



VÍDEO
AKEO

MAIS INFORMAÇÕES
SOBRE O PRODUTO
ACESSE O QR CODE

LANÇAMENTO
Alumínio

CORNER

Alça: 96mm a 640mm



PERFIL

Código	A	B	C	D	E	F	Chapa
50585	160	170	28	10	18	140	15 / 18mm

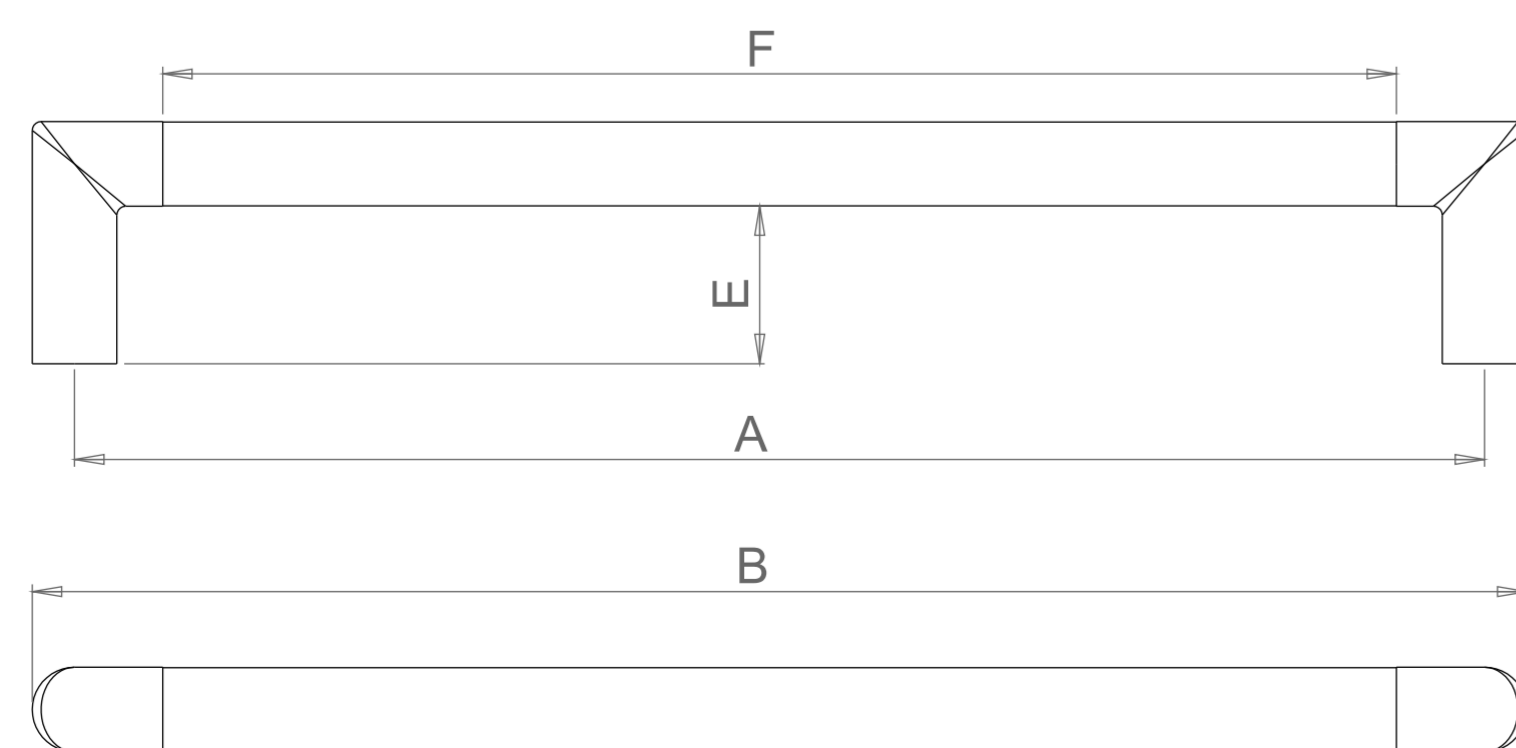
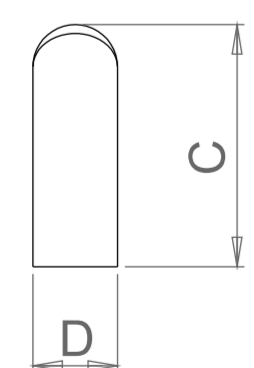

*DIMENSÕES EM MILÍMETROS (mm) / IMAGENS E ACABAMENTOS MERAMENTE ILUSTRATIVOS.

akeo.com.br



Anodizado Natural
/ Prata

Anodizado Champagne
/ Champagne

Black Epóxi
/ Black

Consulte
outras opções
de acabamento.





VÍDEO
AKEO
MAIS INFORMAÇÕES
SOBRE O PRODUTO
ACESSE O QR CODE



PUX. CORNER
BLACK EPÓXI

PUX. CORNER

AKEO ::::

DECOR

Alça: 96mm a 992mm

Acabamentos: Anodizado Natural e Anodizado Champagne.

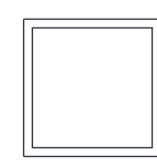
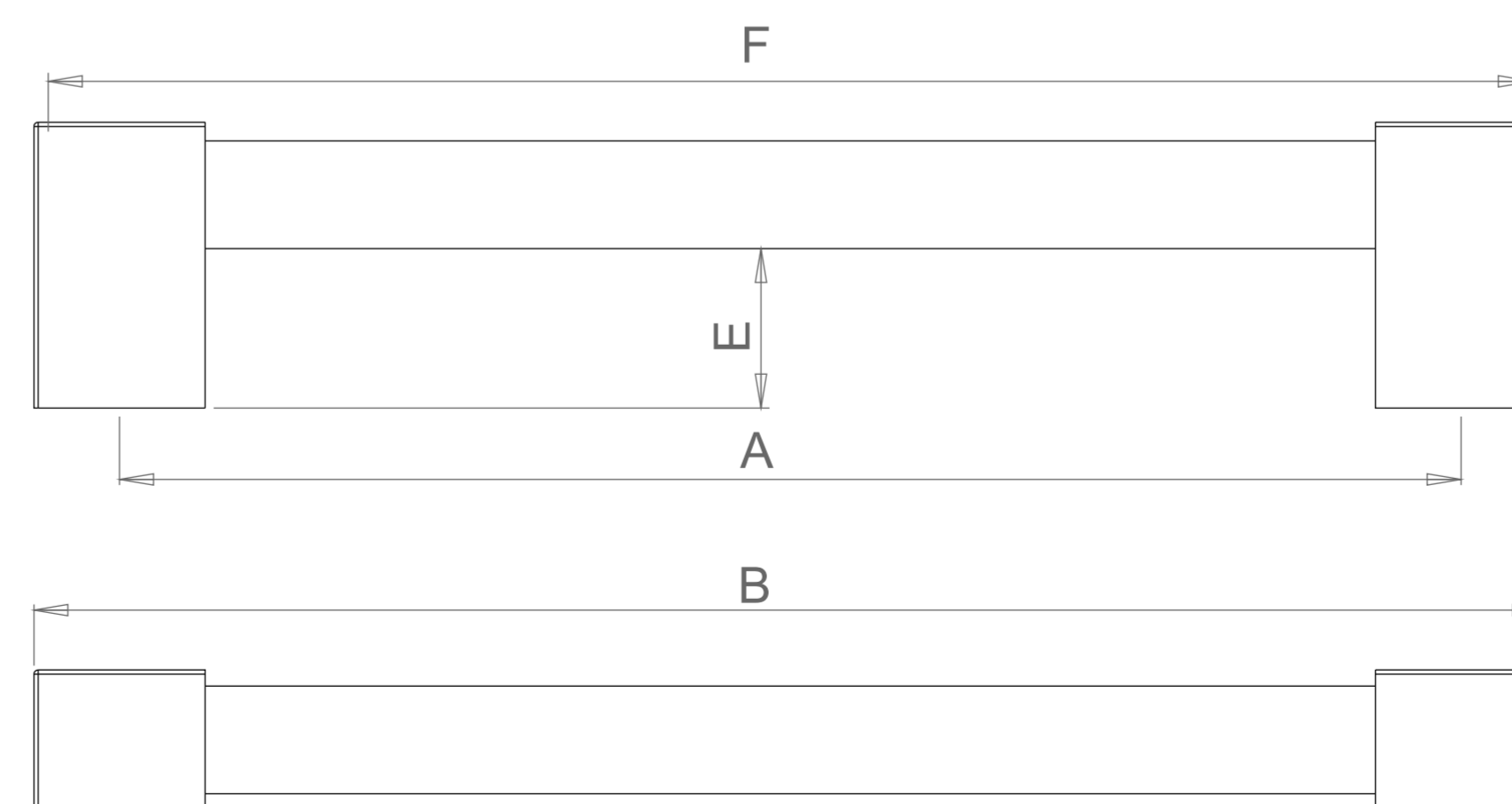
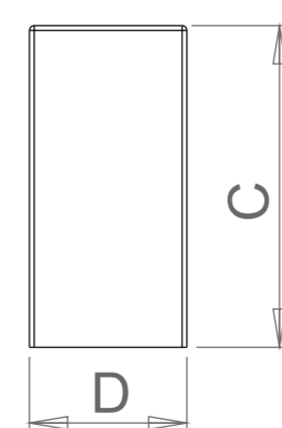
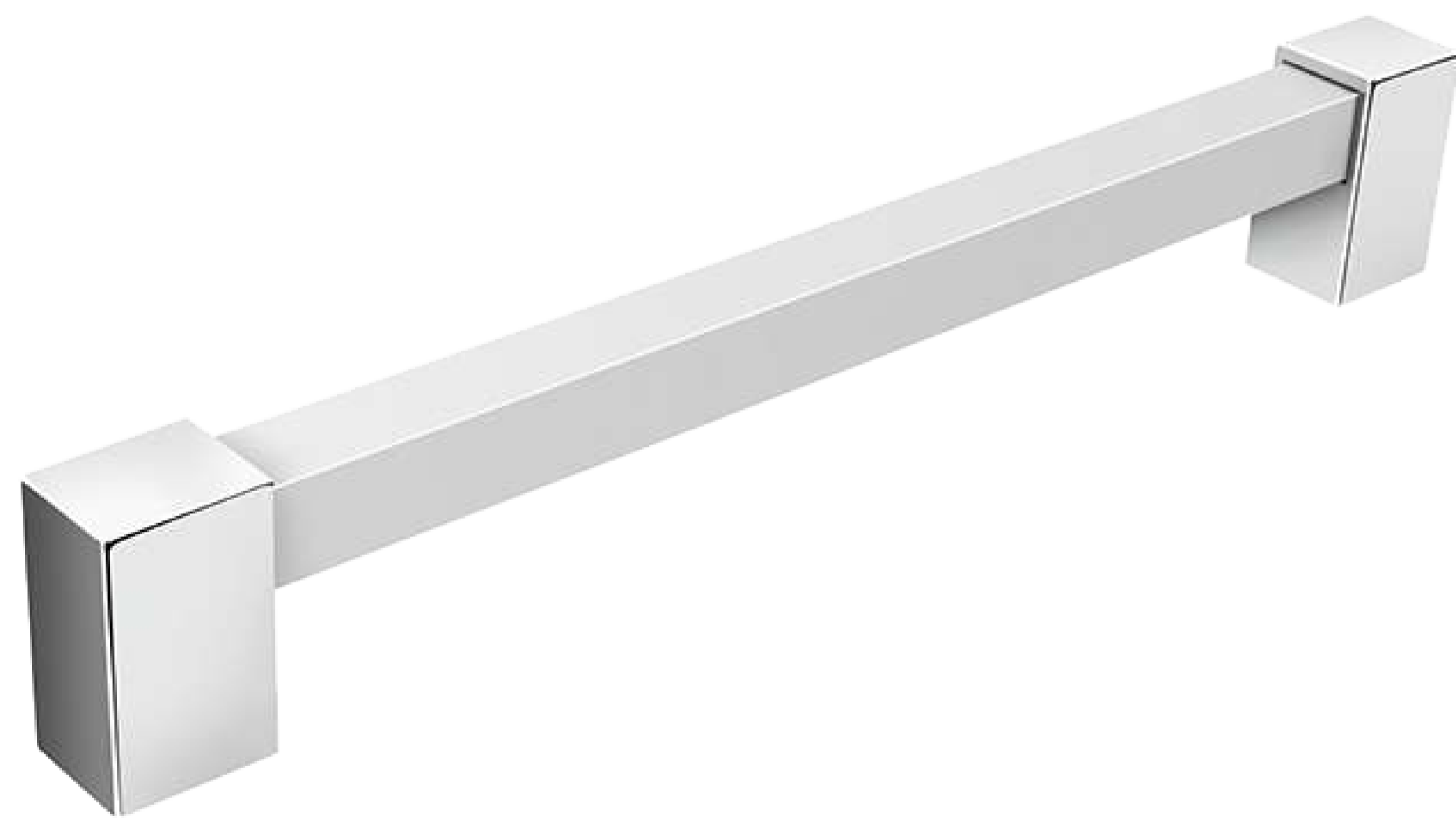

PERFIL

Código	A	B	C	D	E	F	Chapa
50739	160	178	34	17	19	175	15 / 18mm

*DIMENSÕES EM MILÍMETROS (mm) / IMAGENS E ACABAMENTOS MERAMENTE ILUSTRATIVOS.

FREGIO

Alça: 96mm a 768mm

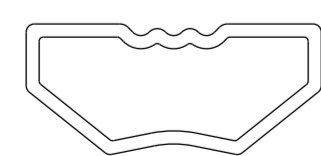
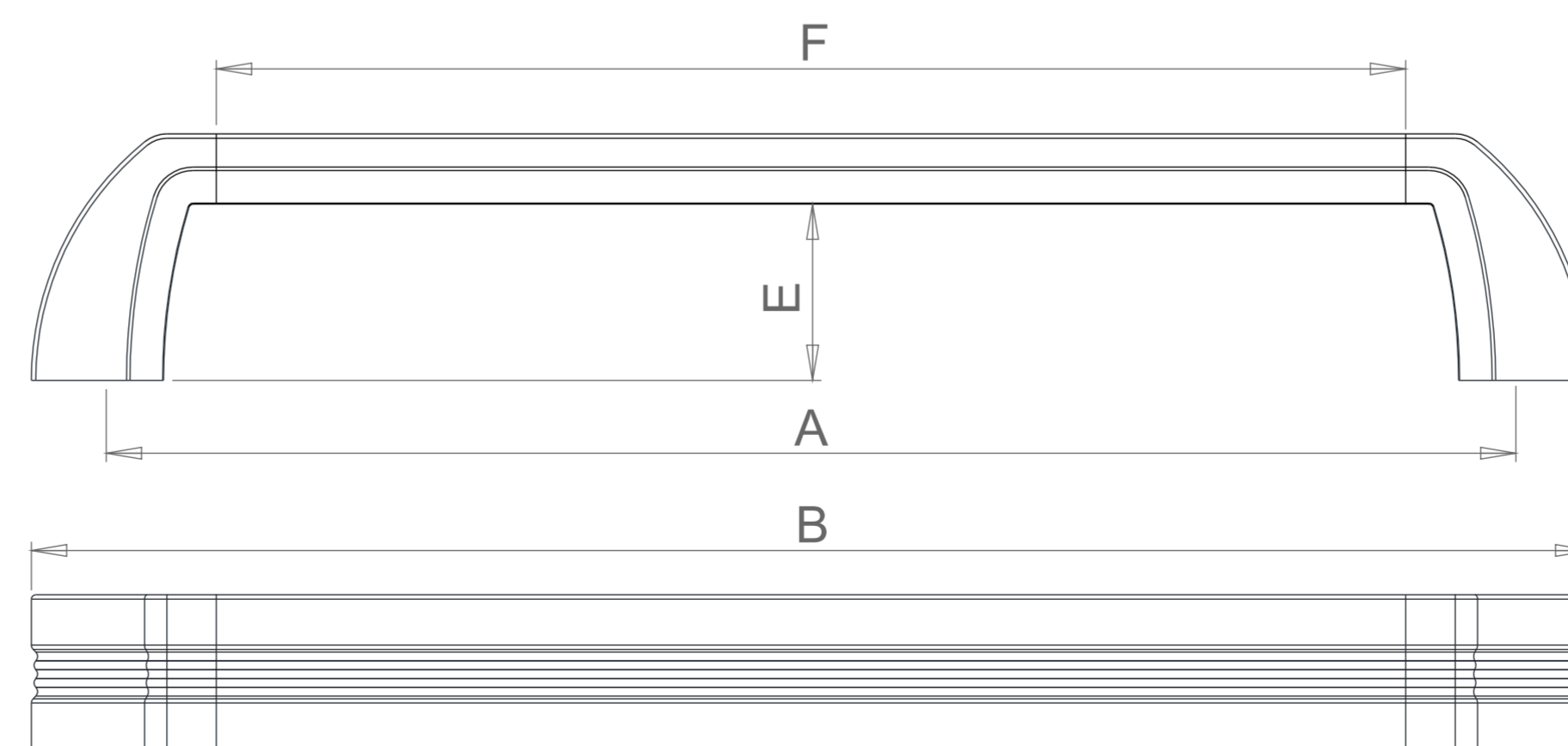
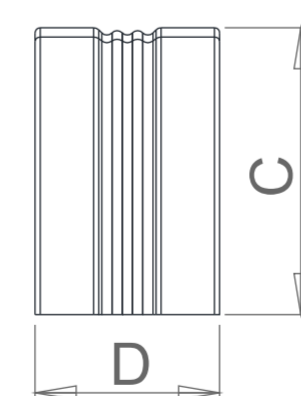
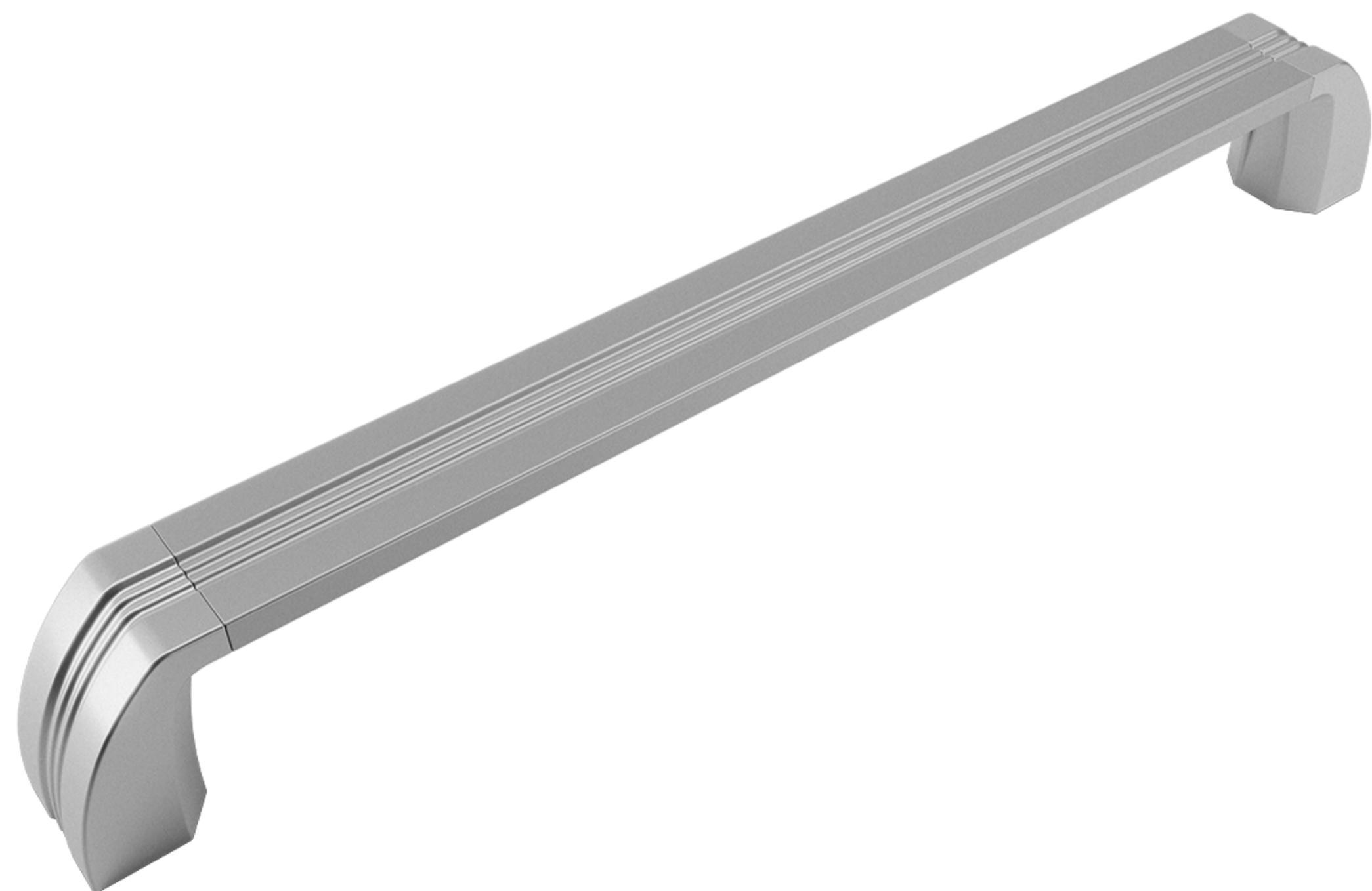

PERFIL

Código	A	B	C	D	E	F	Chapa
50079	160	177	28	18	20	135	15 / 18mm

*DIMENSÕES EM MILÍMETROS (mm) / IMAGENS E ACABAMENTOS MERAMENTE ILUSTRATIVOS.

akeo.com.br

Anodizado Natural
/ Prata

Anodizado Champagne
/ Champagne

Black Epóxi
/ Black

Consulte
outras opções
de acabamento.

VÍDEO
AKEO
MAIS INFORMAÇÕES
SOBRE O PRODUTO
ACESSE O QR CODE



PUX. FRÉGIO



PUX. FRÉGIO
ANOD. CHAMPAGNE

GHALA

Alça: 128mm a 992mm

Acabamentos: Anodizado Natural e Anodizado Champagne.

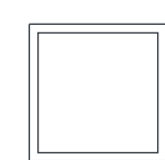
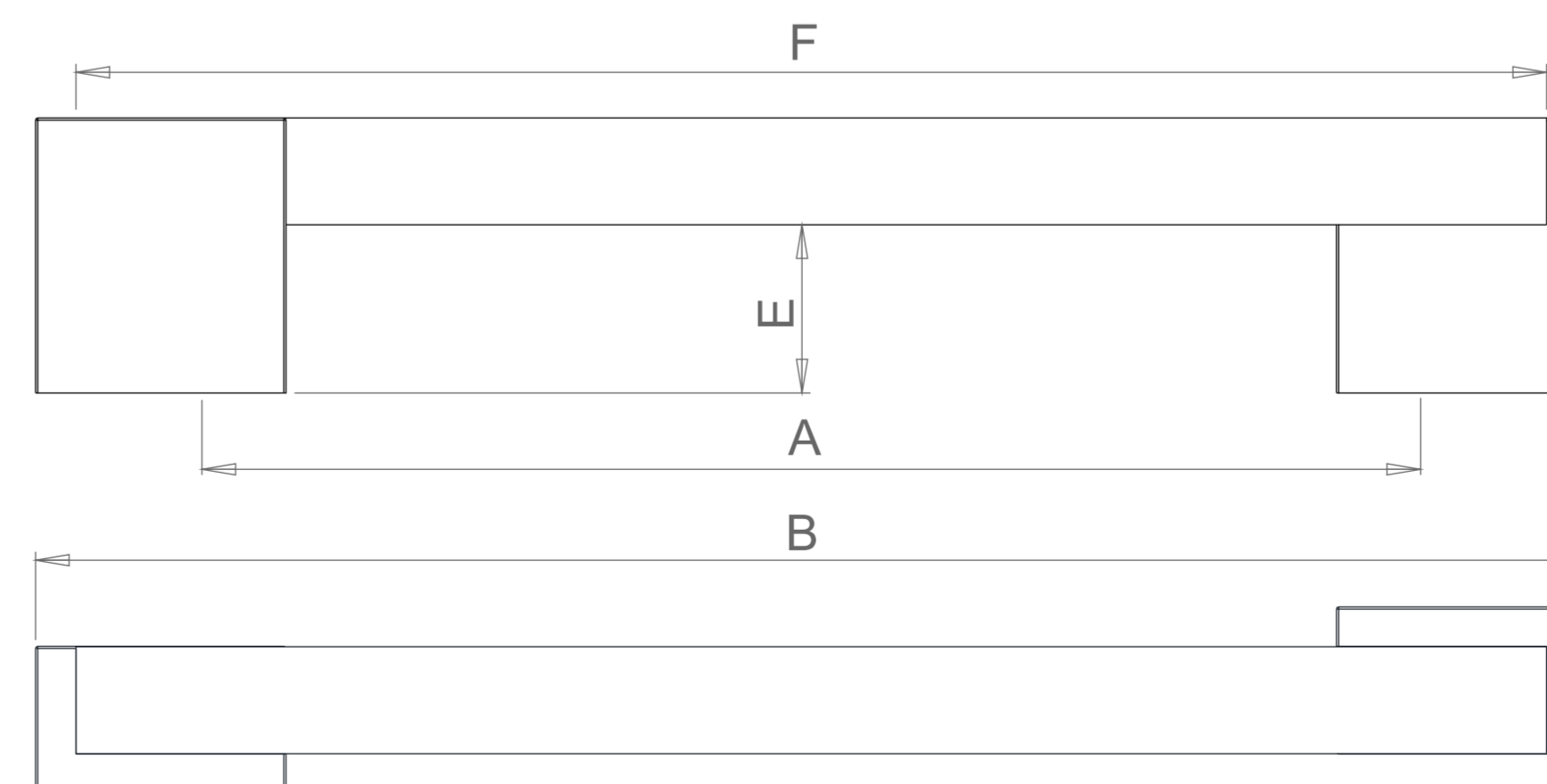
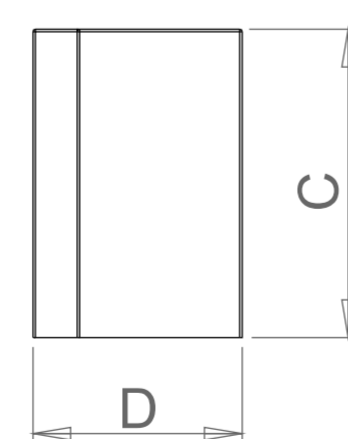
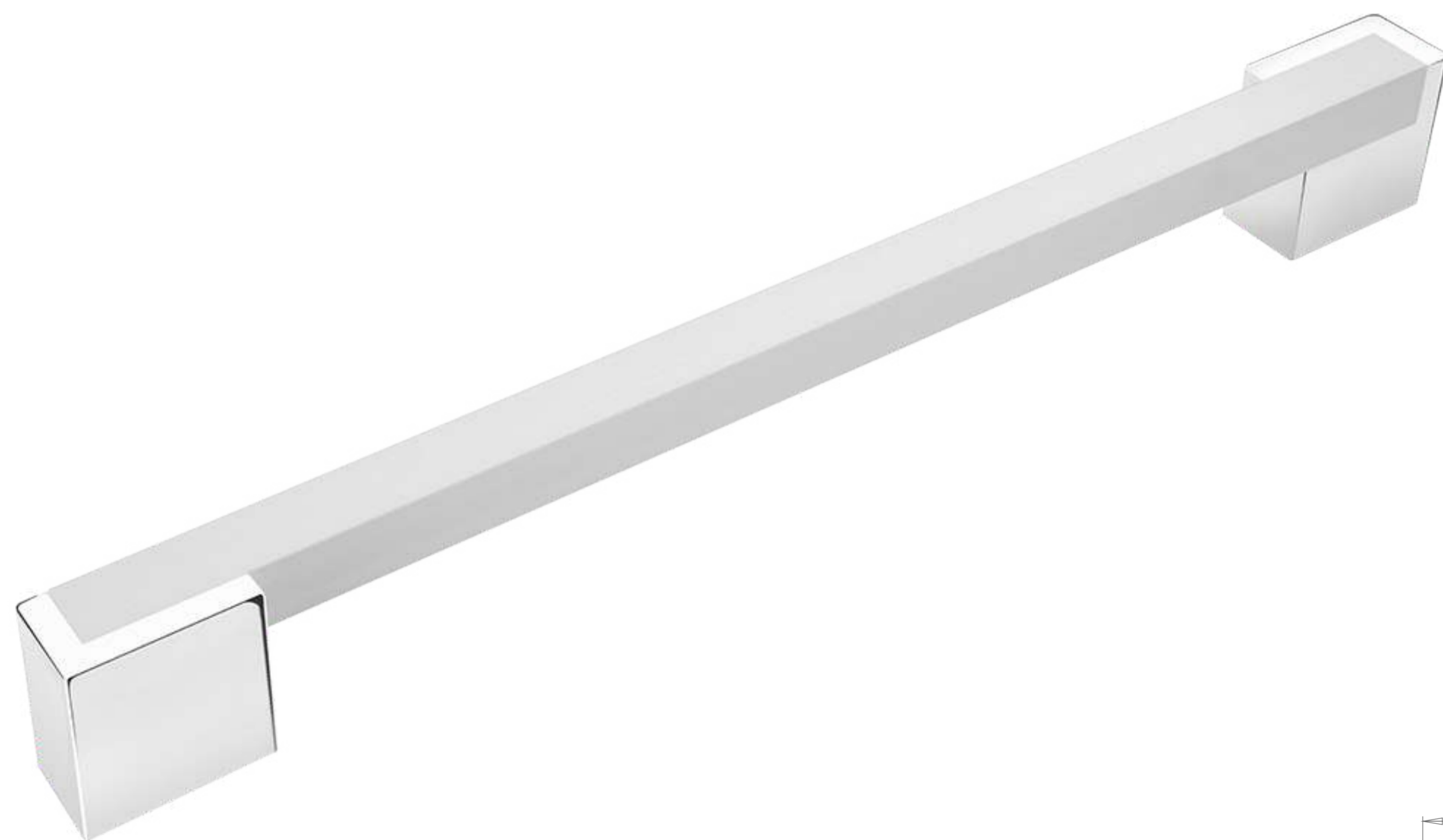

PERFIL

Código	A	B	C	D	E	F	Chapa
50680	160	200	33	22	20	190	15 / 18mm

*DIMENSÕES EM MILÍMETROS (mm) / IMAGENS E ACABAMENTOS MERAMENTE ILUSTRATIVOS.

LANÇAMENTO
Alumínio

GLASS

Alça: 96mm a 704mm

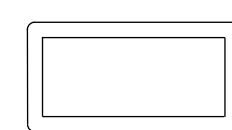

PERFIL

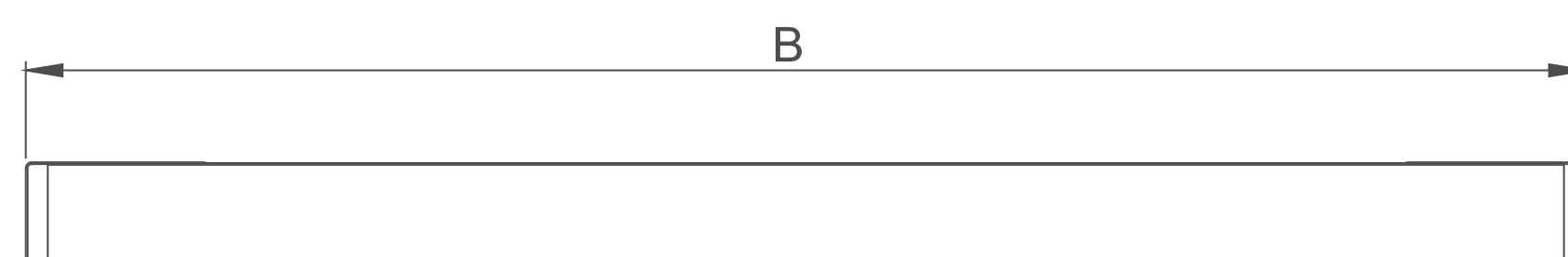
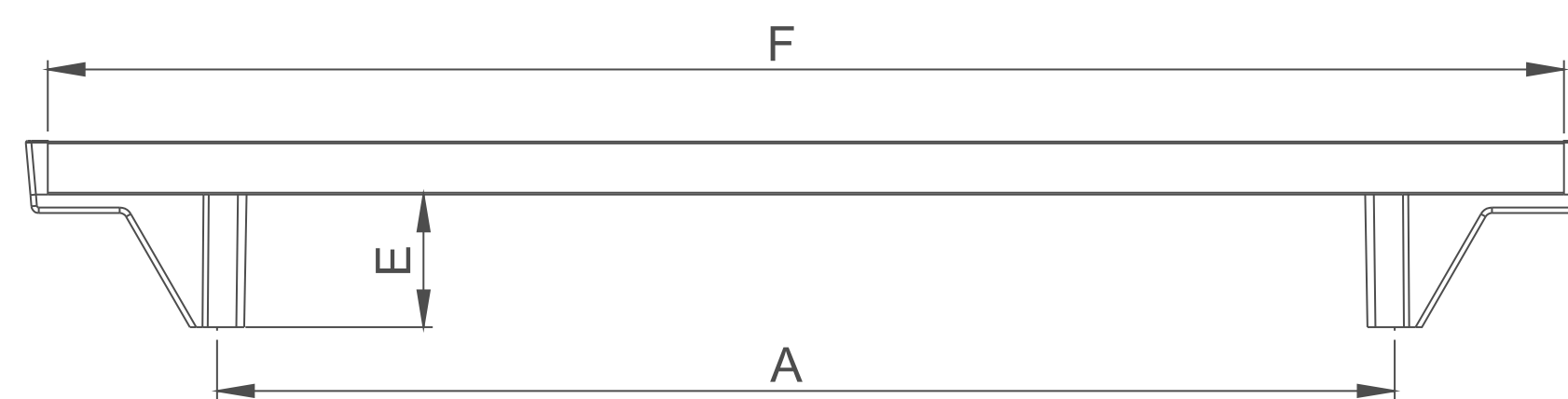
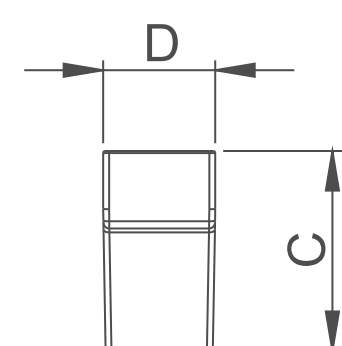

Código	A	B	C	D	E	F	Chapa
50867	160	212	25	14	18	206	15 / 18mm

*DIMENSÕES EM MILÍMETROS (mm) / IMAGENS E ACABAMENTOS MERAMENTE ILUSTRATIVOS.

akeo.com.br

Anodizado Natural
/ Prata

Anodizado Champagne
/ Champagne

Black Epóxi
/ Black

Consulte
outras opções
de acabamento.





PUX. GLASS



LANÇAMENTO
Alumínio

JADE

Alça: 128mm a 704mm

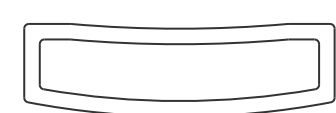

PERFIL

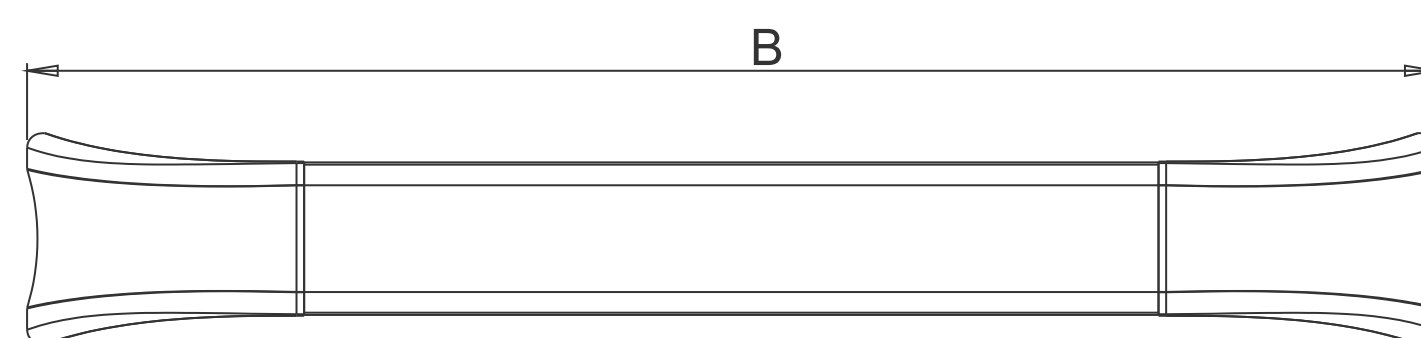
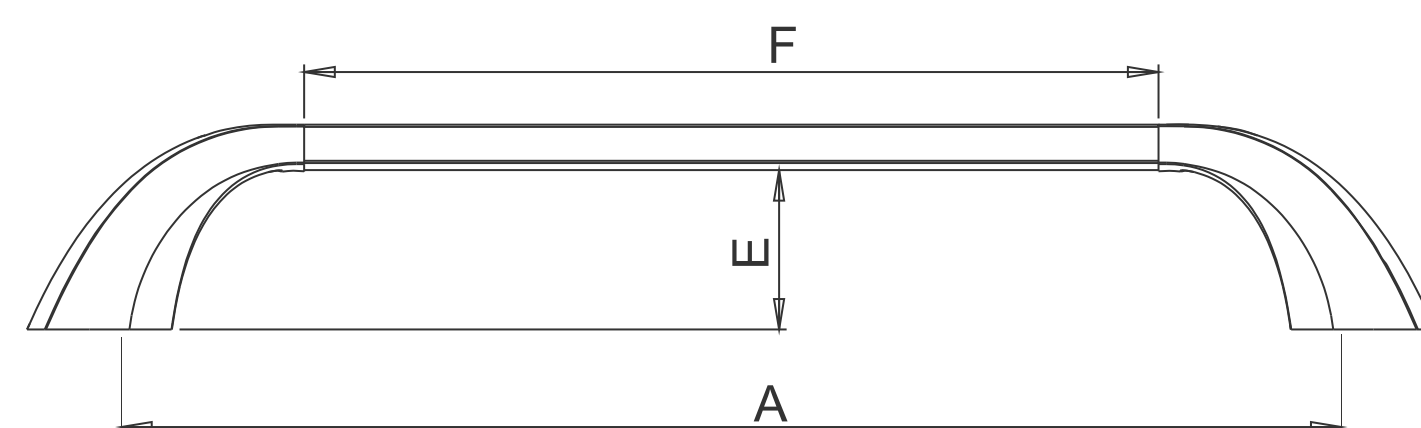
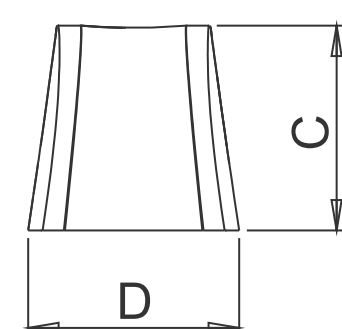

Código	A	B	C	D	E	F	Chapa
50825	160	185	27	28	21	112	15 / 18mm

*DIMENSÕES EM MILÍMETROS (mm) / IMAGENS E ACABAMENTOS MERAMENTE ILUSTRATIVOS.

akeo.com.br



Anodizado Natural
/ Prata

Anodizado Champagne
/ Champagne

Black Epóxi
/ Black

Consulte
outras opções
de acabamento.



PUX. JADE



PUX. JADE
BLACK
EPOXI

LIVELLO

Alça: 96mm a 768mm

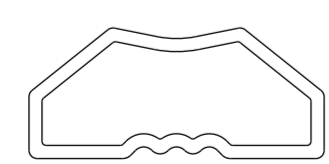
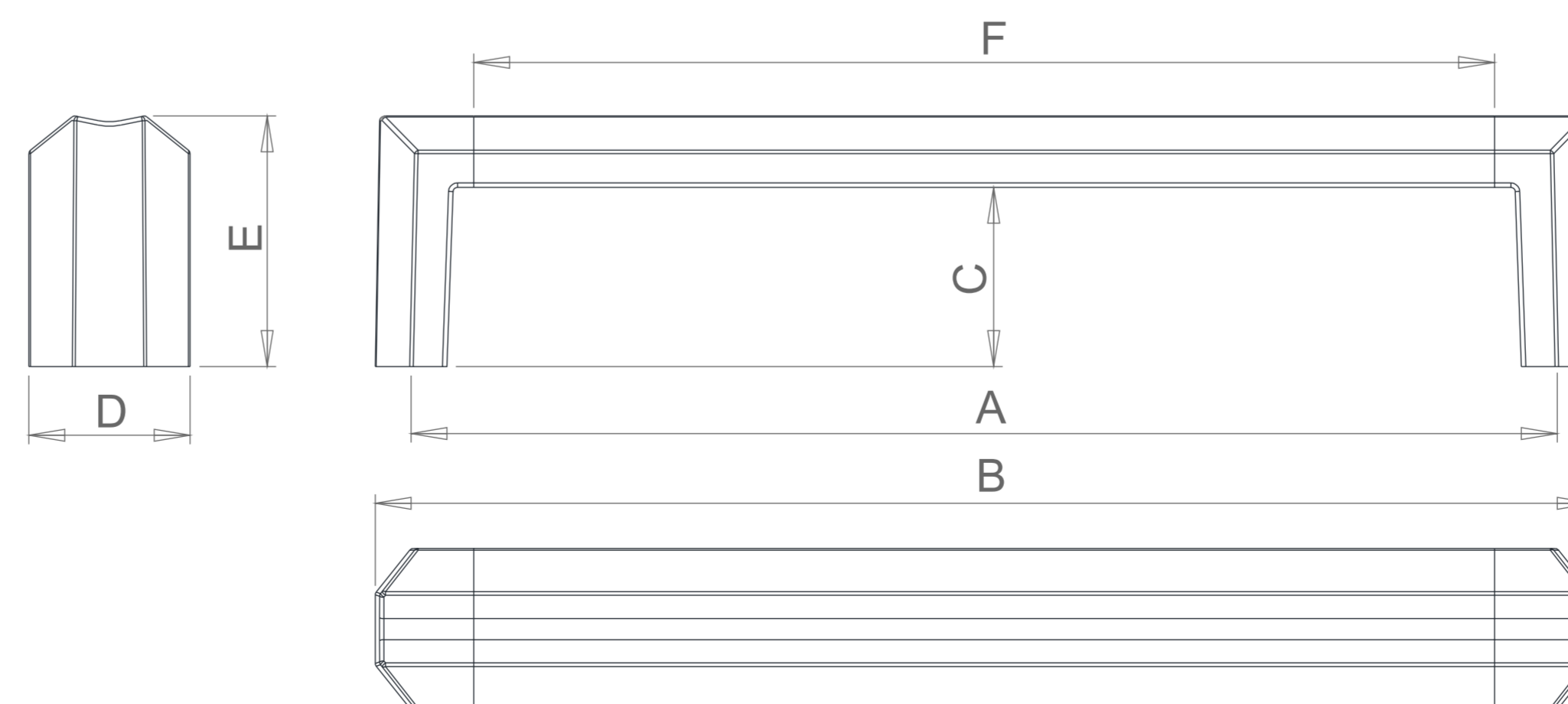

PERFIL

Código	A	B	C	D	E	F	Chapa
50078	160	168	28	18	20	146	15 / 18mm

Anodizado Natural / Prata

Anodizado Champagne / Champagne

Black Epóxi / Black



*DIMENSÕES EM MILÍMETROS (mm) / IMAGENS E ACABAMENTOS MERAMENTE ILUSTRATIVOS.

akeo.com.br

Consulte outras opções de acabamento.



VÍDEO
AKEO

MAIS INFORMAÇÕES
SOBRE O PRODUTO
ACESSE O QR CODE

PUX. LIVELLO



PUX. LIVELLO
ANOD. CHAMPAGNE



LANÇAMENTO
Alumínio

LESS

Alça: 64mm a 800mm

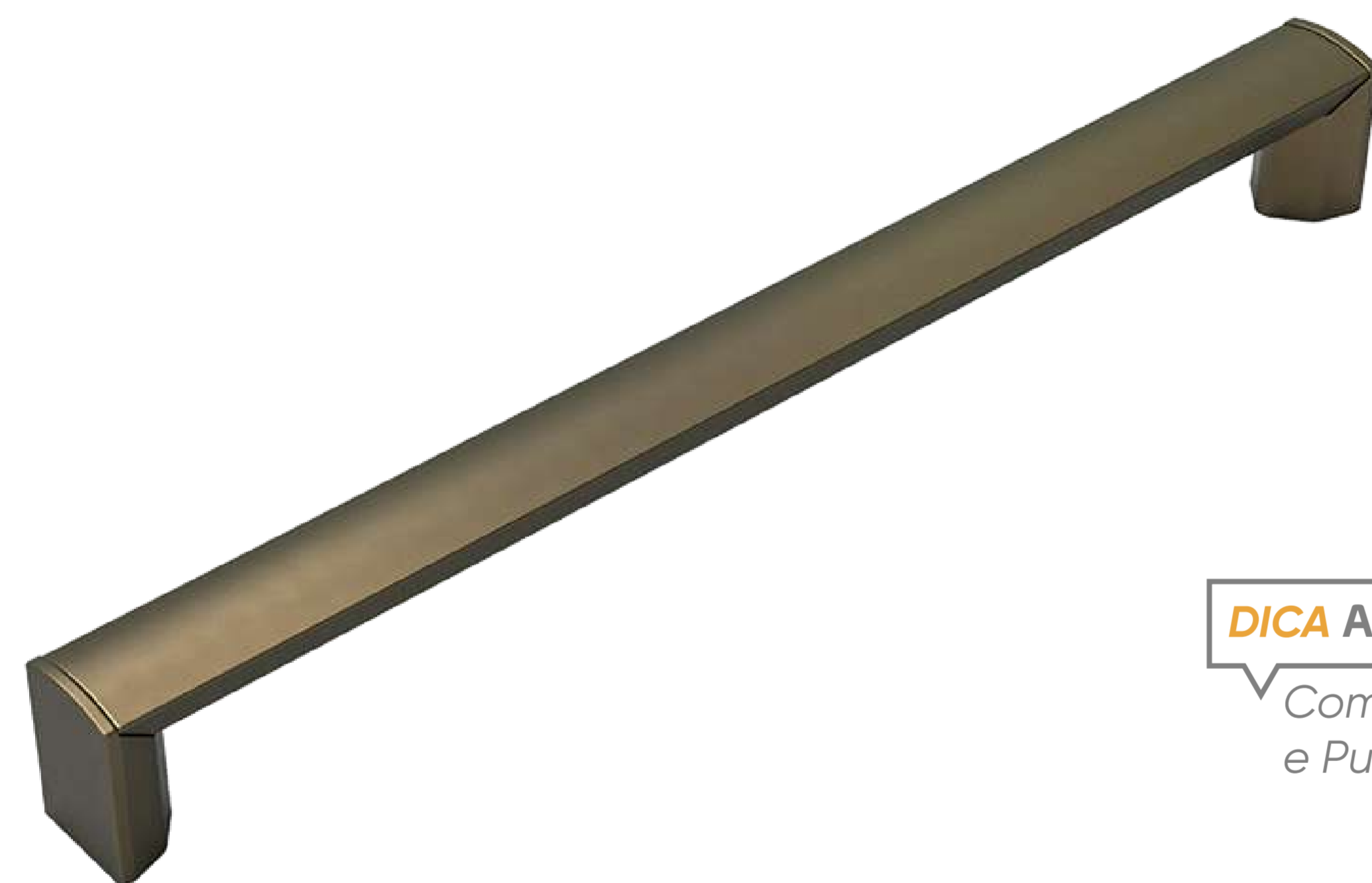

DICA AKEO!

Combine com: Puxador Athos Bas e Puxador Athos Courbe.



PERFIL

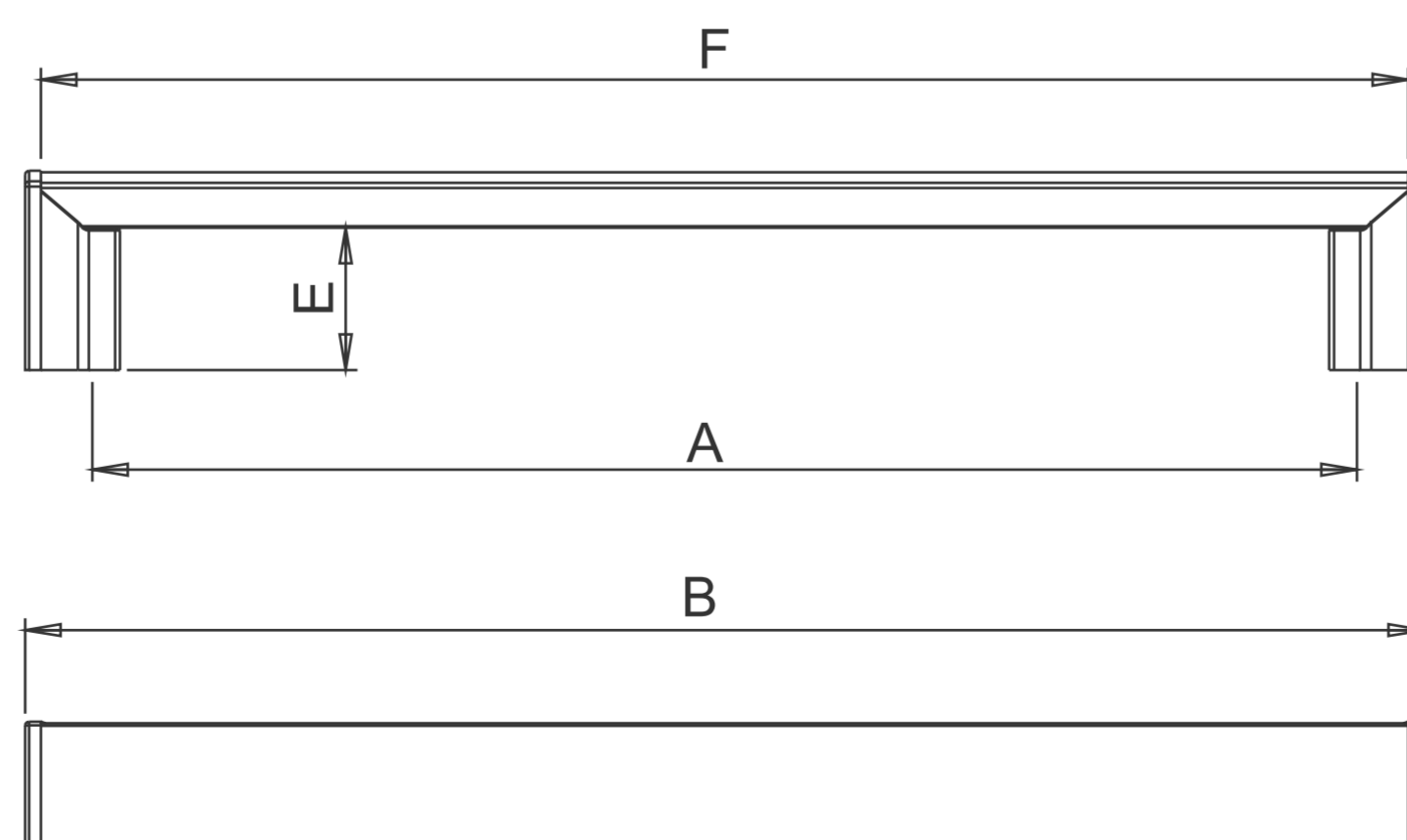
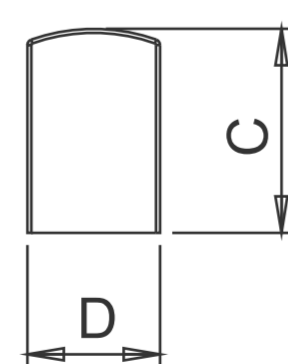

Código	A	B	C	D	E	F	Chapa
50685	160	177	25	16,4	18	173	15 / 18mm

*DIMENSÕES EM MILÍMETROS (mm) / IMAGENS E ACABAMENTOS MERAMENTE ILUSTRATIVOS.

akeo.com.br

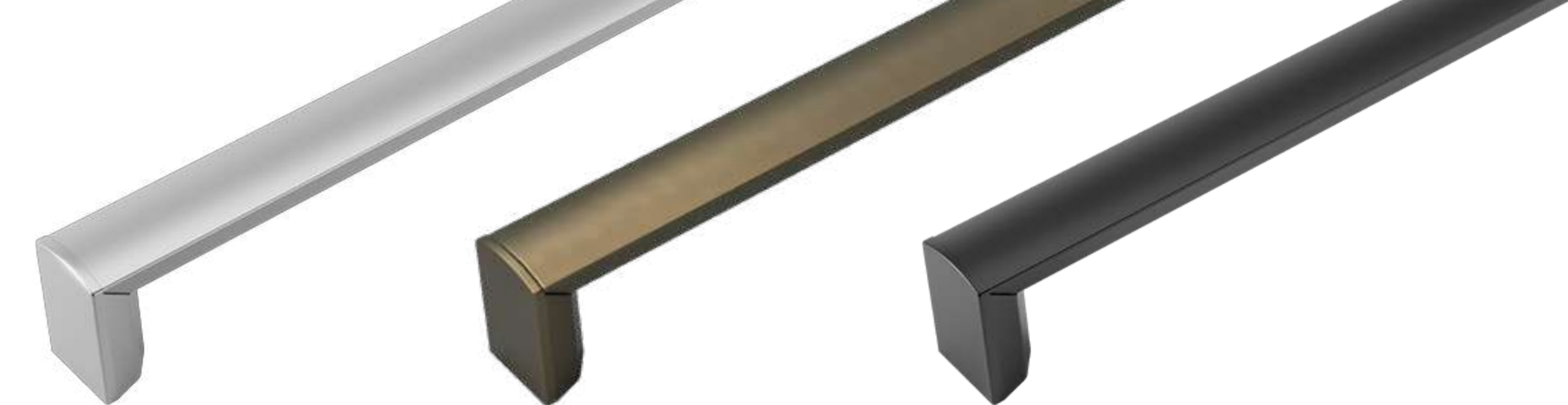

Anodizado Natural
/ Prata

Anodizado Champagne
/ Champagne

Black Epóxi
/ Black

Consulte
outras opções
de acabamento.



PUX. LESS

PUX. LESS
ANOD. NATURAL

••••• AKEO

VÍDEO
AKEO

MAIS INFORMAÇÕES
SOBRE O PRODUTO
ACESSE O QR CODE



LOFT

Alça: 96mm a 992mm

Acabamentos: Anodizado Natural, Anodizado Champagne e Black Epóxi.

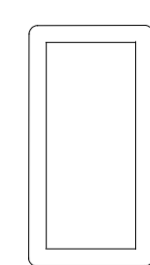
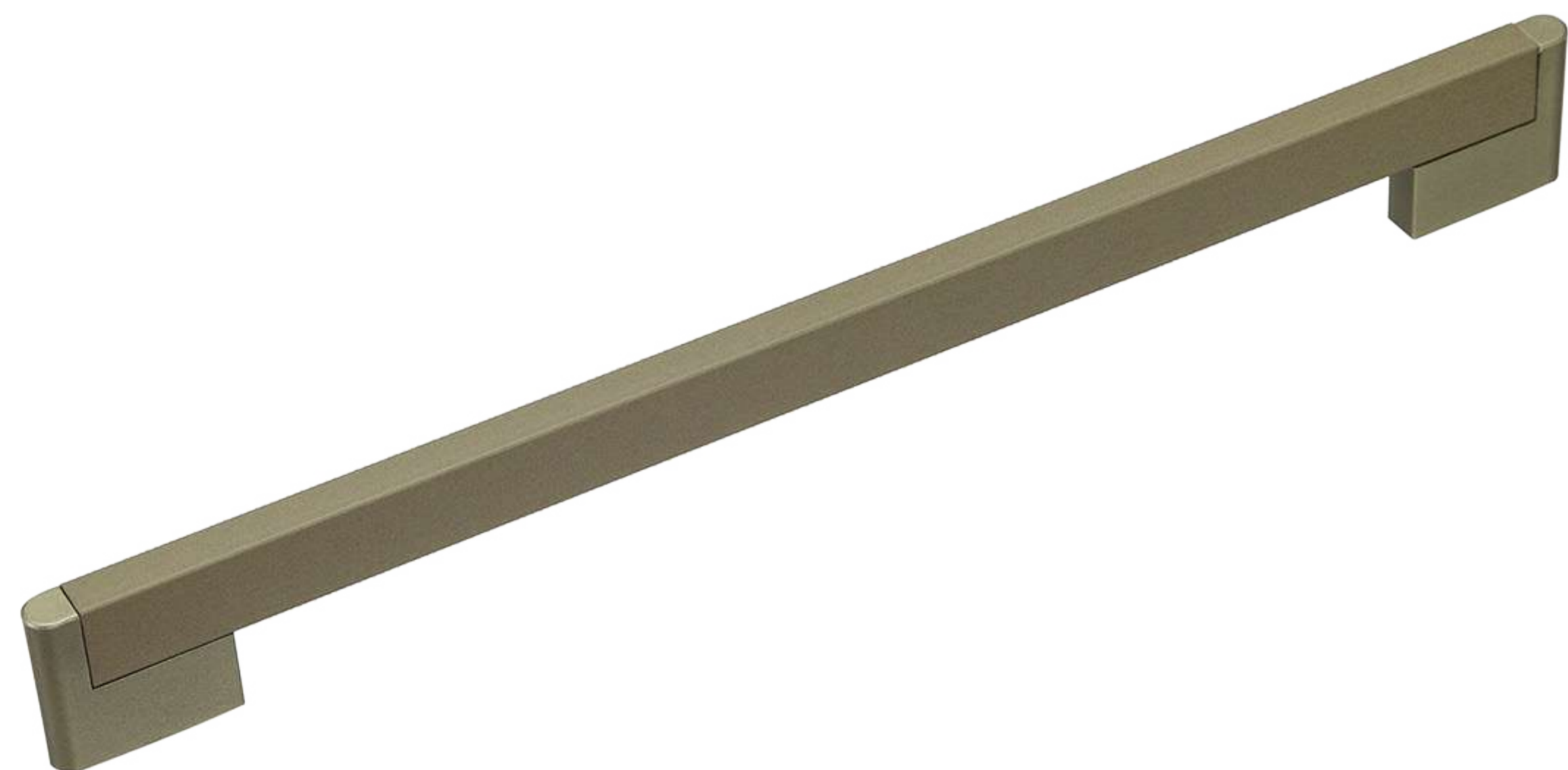

PERFIL

Código	A	B	C	D	E	F	Chapa
50674	160	188	28	7	14	175	15 / 18mm

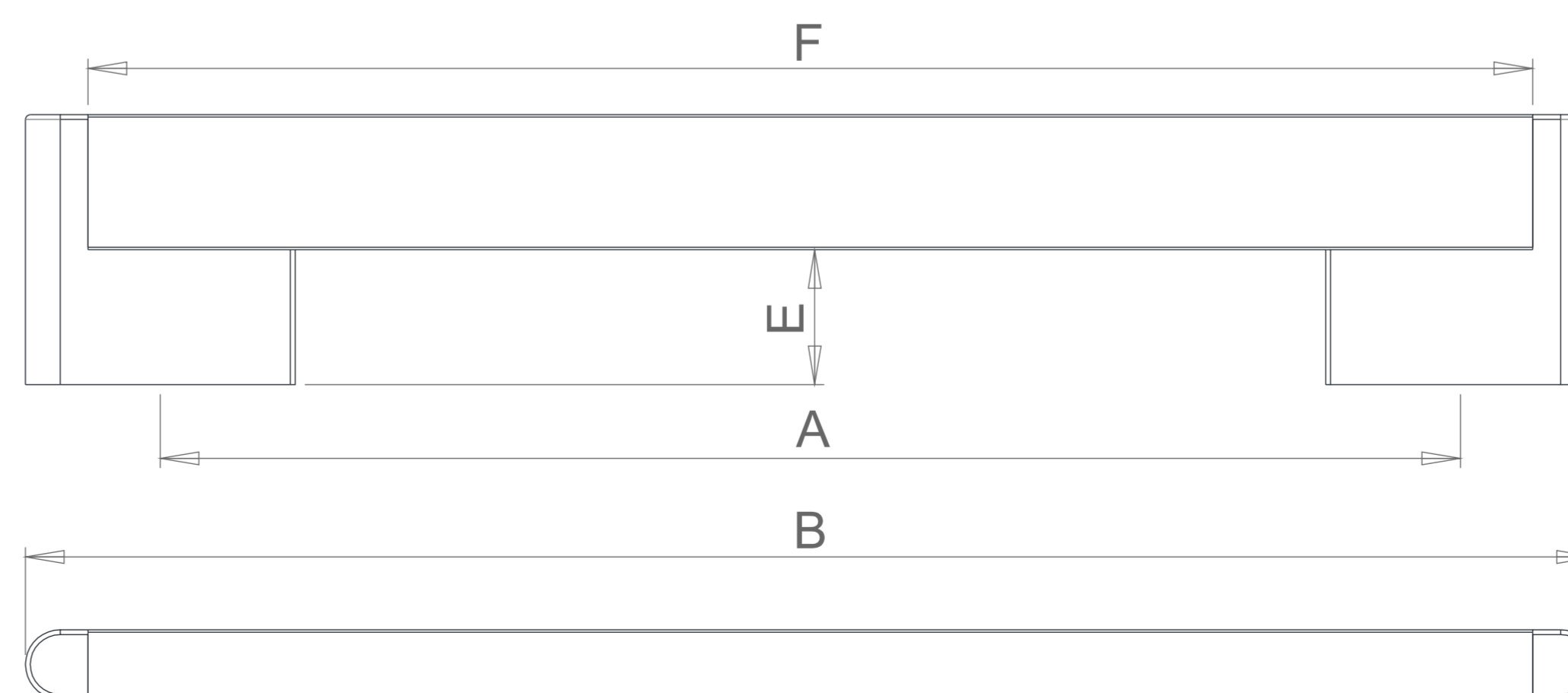
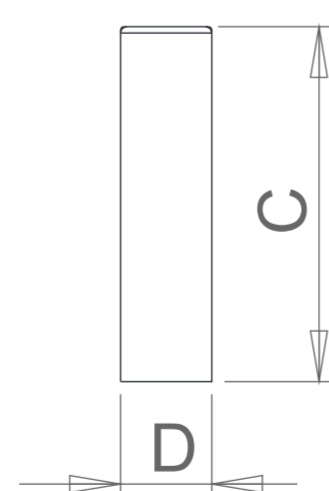

*DIMENSÕES EM MILÍMETROS (mm) / IMAGENS E ACABAMENTOS MERAMENTE ILUSTRATIVOS.

akeo.com.br

MATTEO

Alça: 96mm a 1056mm

Acabamentos: Anodizado Natural, Anodizado Champagne e Black Epóxi.

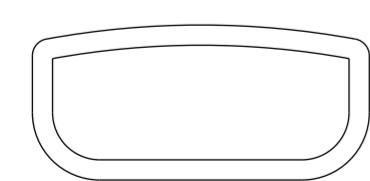
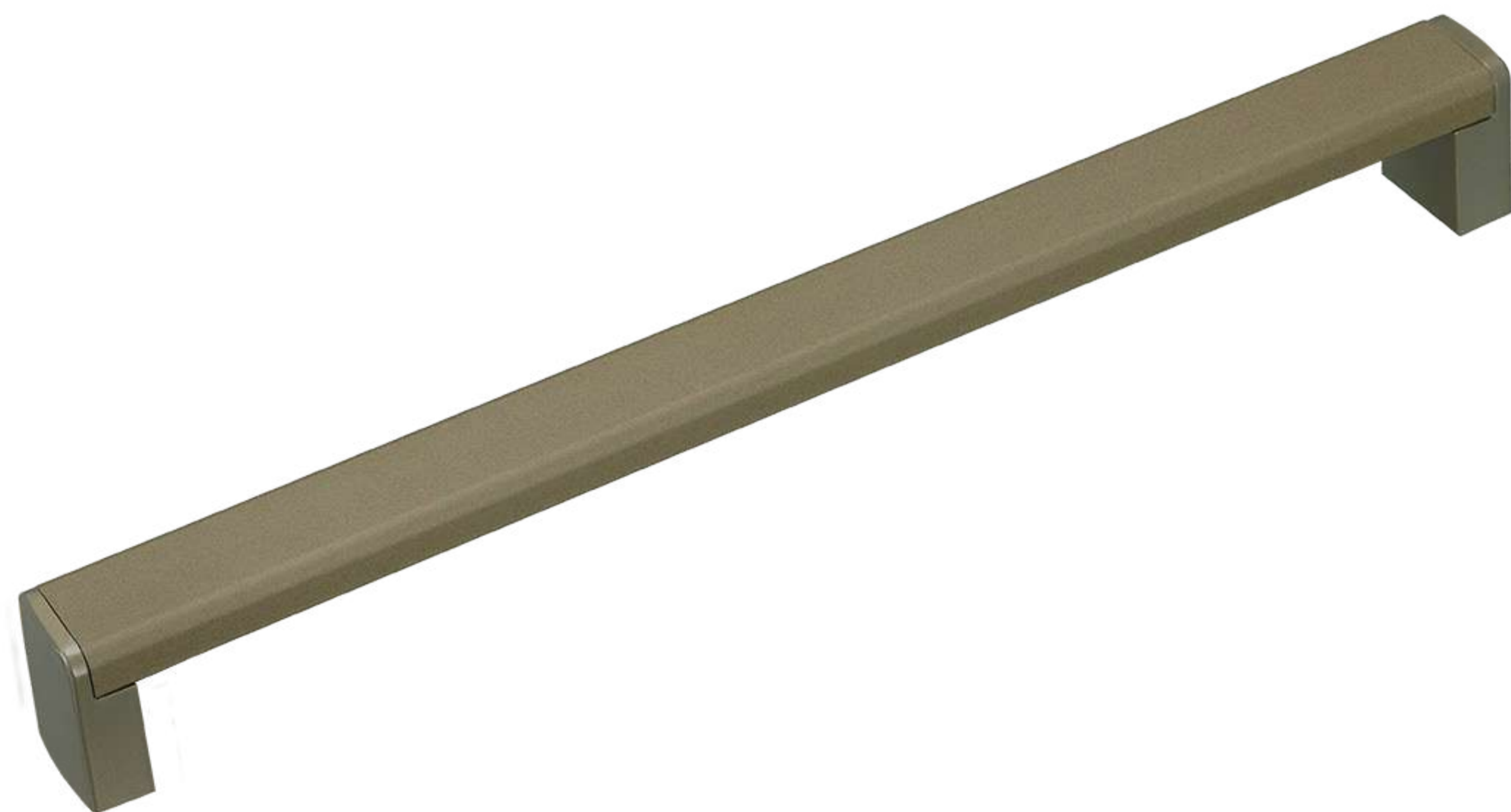

PERFIL

Código	A	B	C	D	E	F	Chapa
50001	160	172	29	20	20	165	15 / 18mm

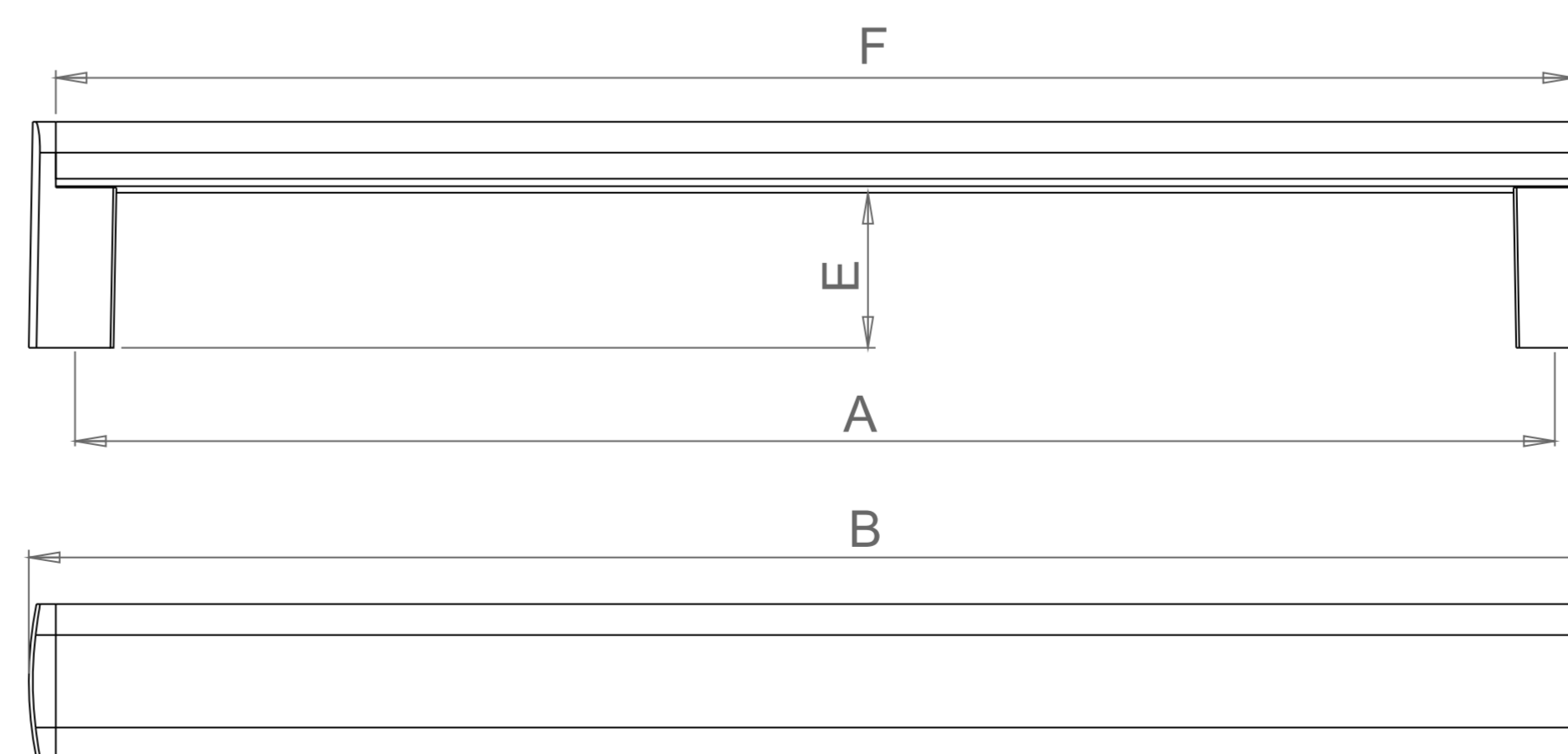
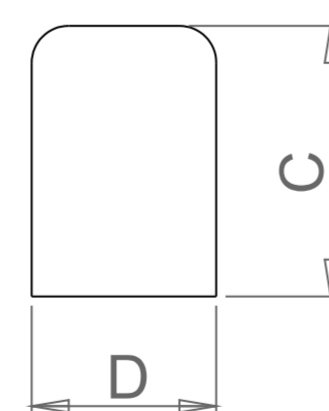

*DIMENSÕES EM MILÍMETROS (mm) / IMAGENS E ACABAMENTOS MERAMENTE ILUSTRATIVOS.

MYDAS

Alça: 288mm a 1056mm

Acabamentos: Anodizado Champagne e Black Epóxi.

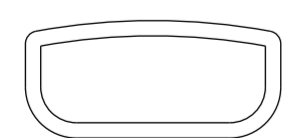
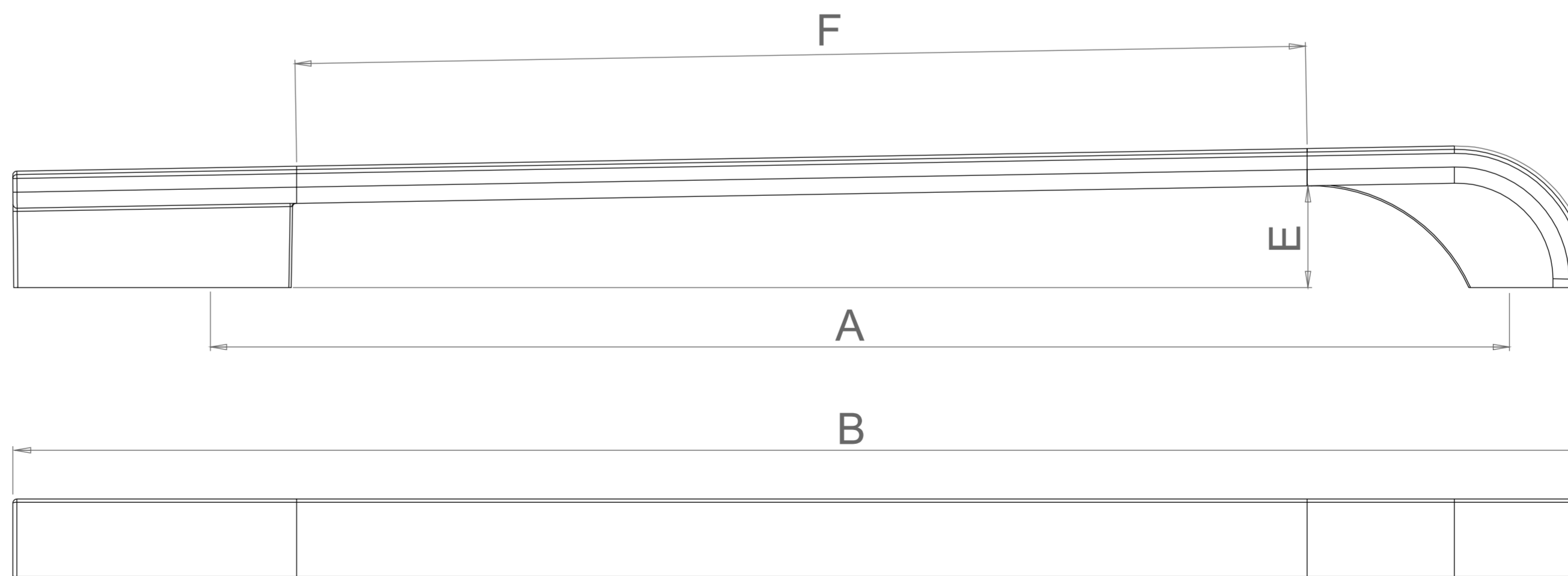
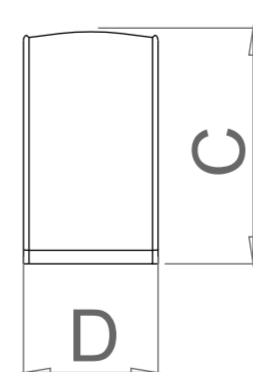

PERFIL

Código	A	B	C	D	E	F	Chapa
50690	576	645	35	20	25	505	15 / 18mm

*DIMENSÕES EM MILÍMETROS (mm) / IMAGENS E ACABAMENTOS MERAMENTE ILUSTRATIVOS.

PÁDUA

Alça: 96mm a 992mm

Acabamentos: Anodizado Natural, Anodizado Champagne e Black Epóxi.

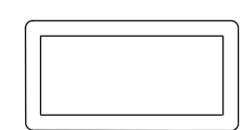
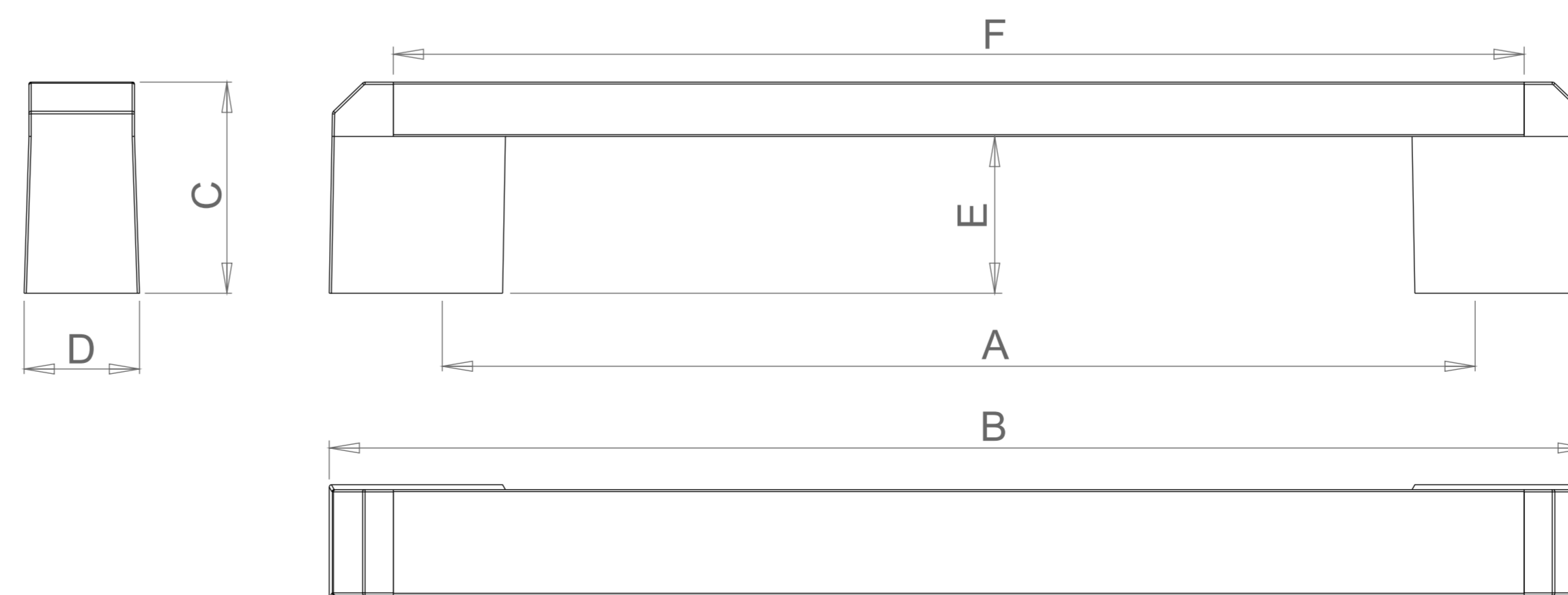
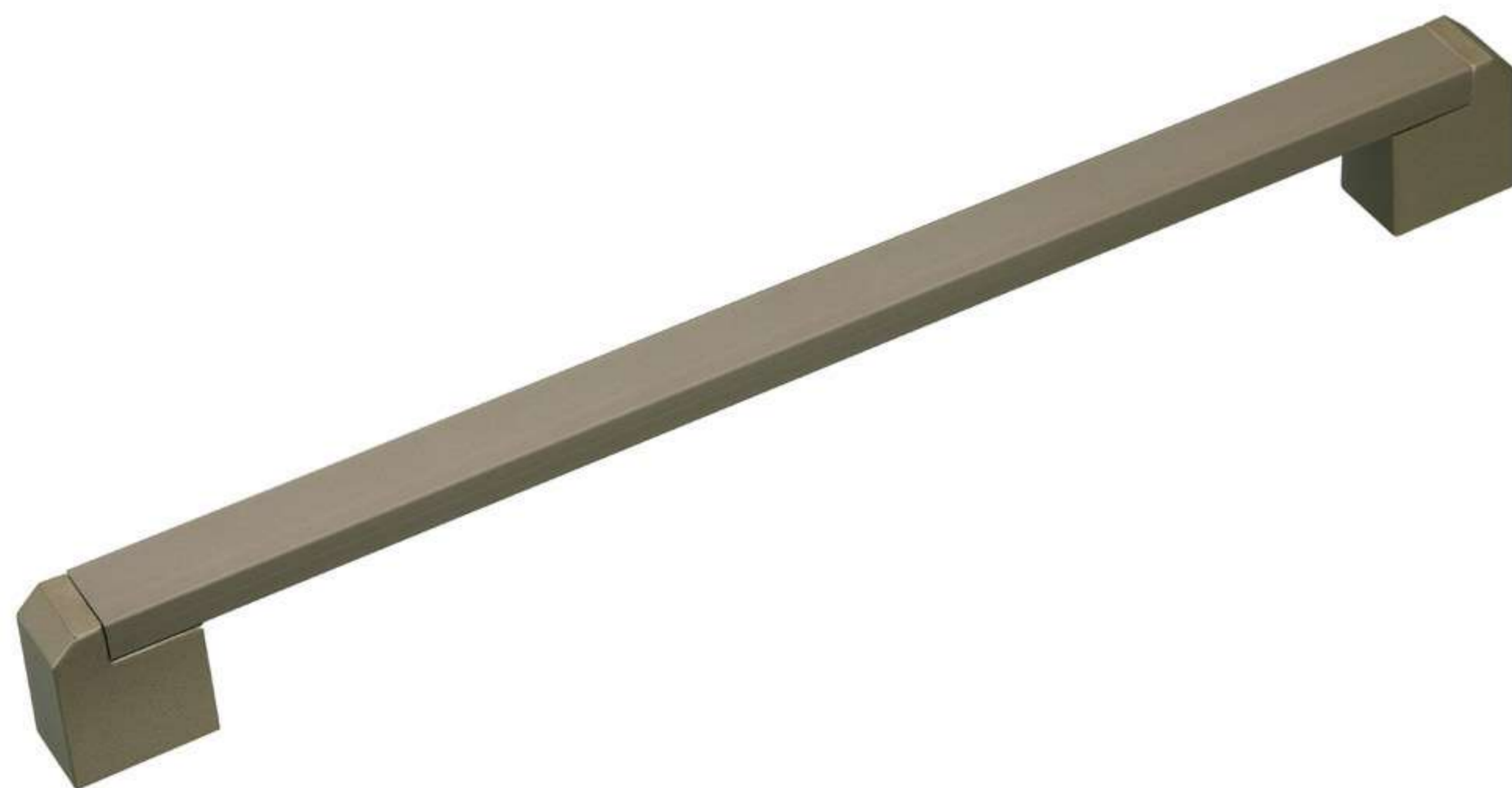

PERFIL

Código	A	B	C	D	E	F	Chapa
50804	160	200	28	15	21	173	15 / 18mm

*DIMENSÕES EM MILÍMETROS (mm) / IMAGENS E ACABAMENTOS MERAMENTE ILUSTRATIVOS.

PRINCE

Alça: 128mm a 1056mm

Acabamentos: Anodizado Natural, Anodizado Champagne e Black Epóxi.

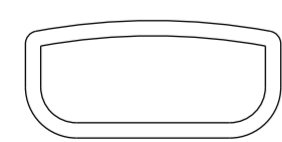
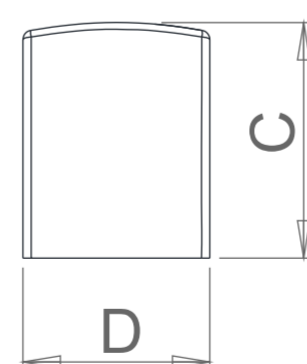

PERFIL

Código	A	B	C	D	E	F	Chapa
50815	160	185	25	20	16	99	15 / 18mm

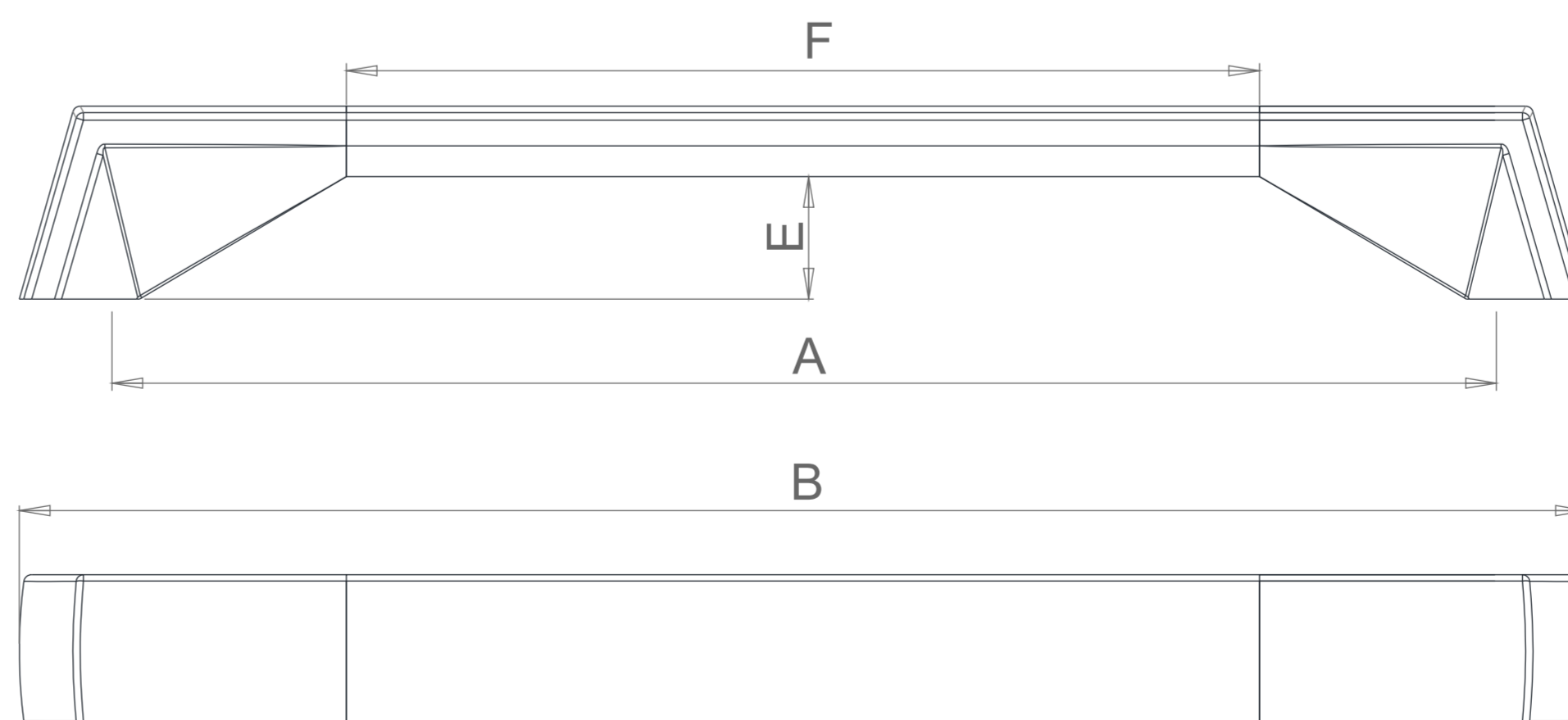

*DIMENSÕES EM MILÍMETROS (mm) / IMAGENS E ACABAMENTOS MERAMENTE ILUSTRATIVOS.

LANÇAMENTO
Alumínio

RIVER

Alça:

Acabamentos: Sob consulta.



Anodizado Champagne /
Champagne



Black Epóxi /
Black



Dourado /
Dourado

*Consulte
outras opções
de acabamento.*

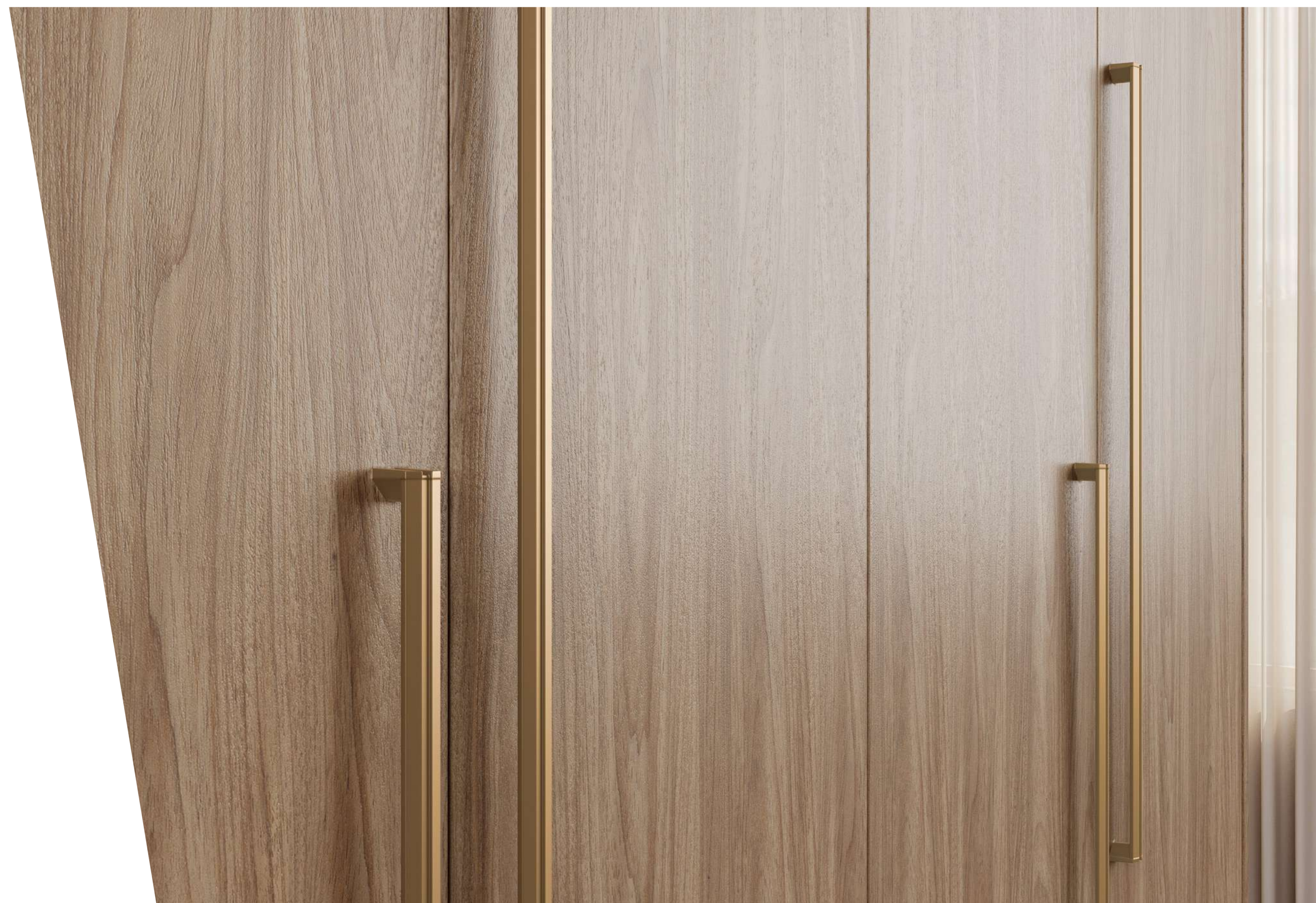

*DIMENSÕES EM MILÍMETROS (mm) / IMAGENS E ACABAMENTOS MERAMENTE ILUSTRATIVOS.

PUX. RIVER



SETA

Alça: 64mm a 640mm

Acabamentos: Anodizado Natural

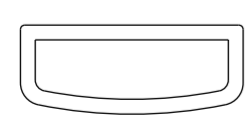
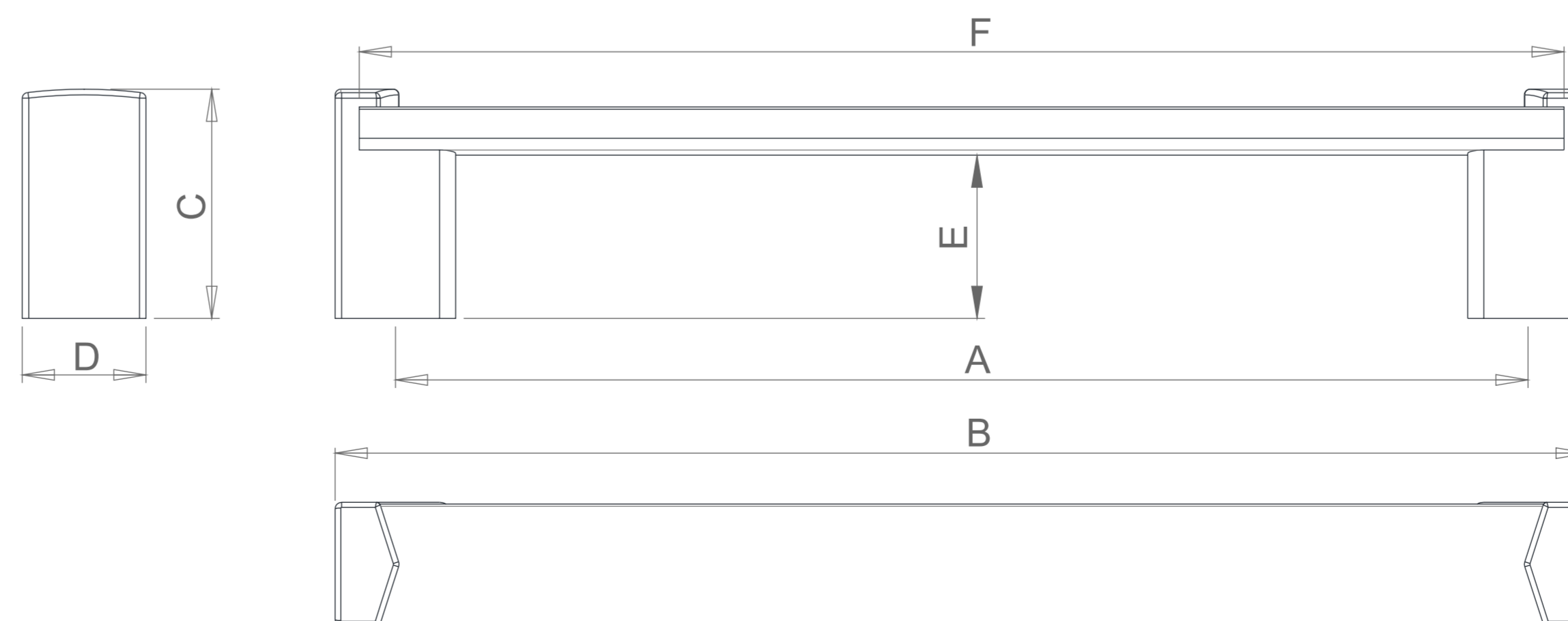

PERFIL

Código	A	B	C	D	E	F	Chapa
50681	160	175	29	15	20	169	15 / 18mm

*DIMENSÕES EM MILÍMETROS (mm) / IMAGENS E ACABAMENTOS MERAMENTE ILUSTRATIVOS.

LANÇAMENTO
Alumínio

SILKY HAUT

Alça: 128mm a 704mm

Acabamentos: Anodizado Natural, Anodizado Champagne e Black Epóxi.



DICA AKEO!

Combine com: Puxador Silky Bas e Puxador Silky Front.

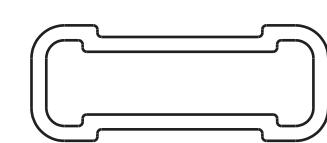

PERFIL

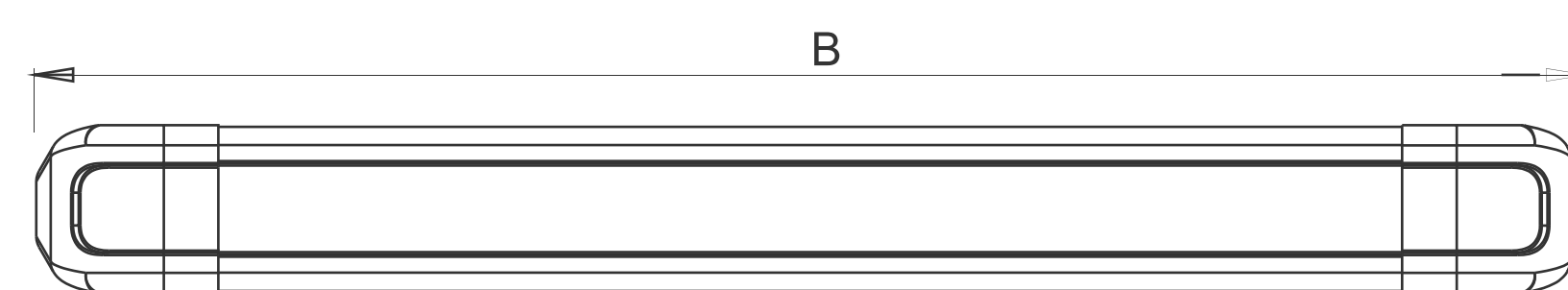
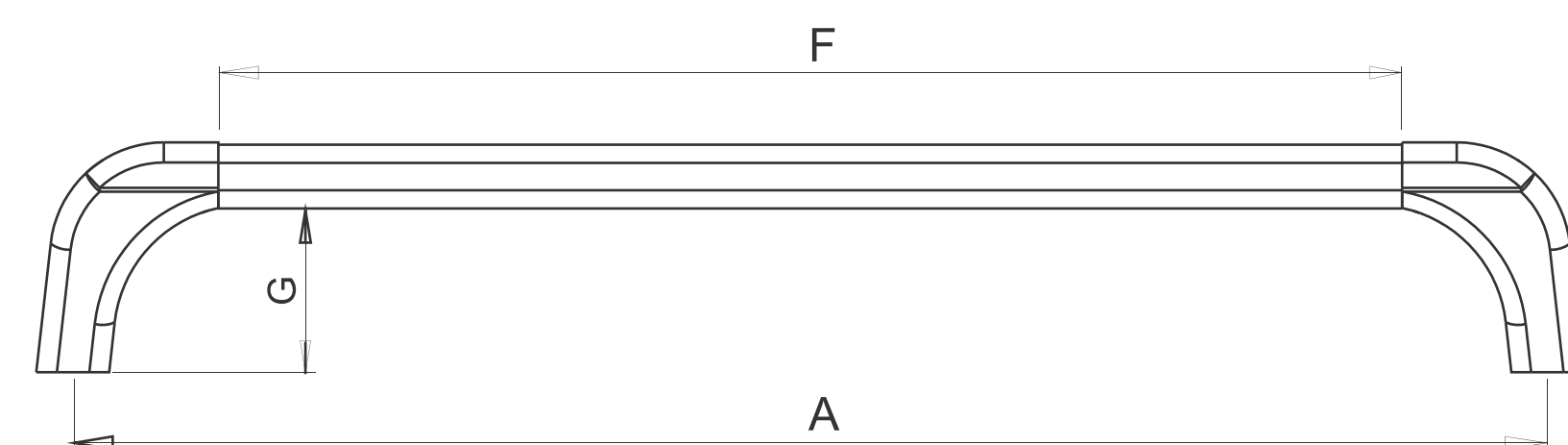
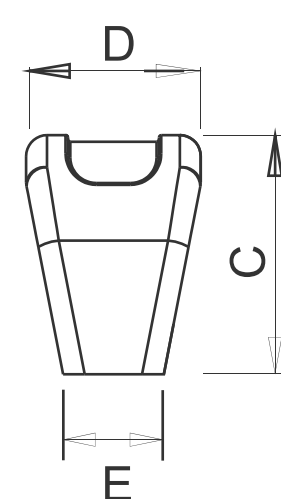

Código	A	B	C	D	E	F	G	Chapa
50593	160	170	25	18	10,6	130	18	15 / 18mm

*DIMENSÕES EM MILÍMETROS (mm) / IMAGENS E ACABAMENTOS MERAMENTE ILUSTRATIVOS.

akeo.com.br



:::: AKEO



○ PUX. SILKY HAUT
ANOD. NATURAL

PUX. SILKY HAUT

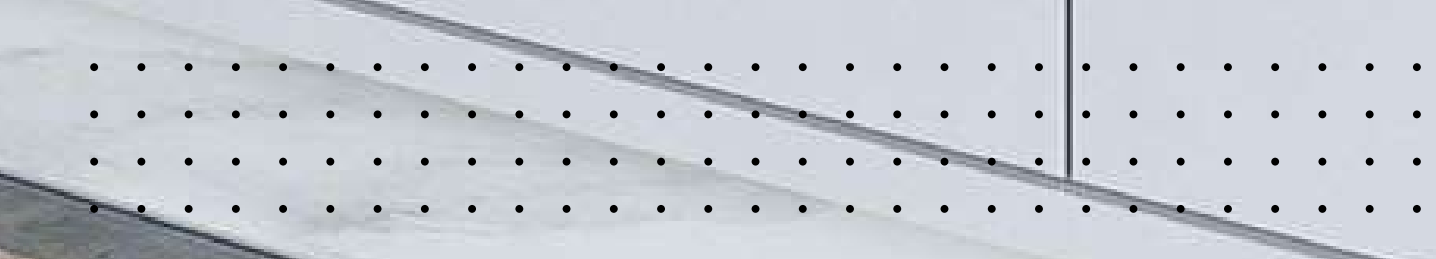

LANÇAMENTO
Alumínio

SILKY BAS

Perfil Puxador: 96mm a 512mm



DICA AKEO!

Combine com: Puxador Silky Haut e Puxador Silky Front.



PERFIL

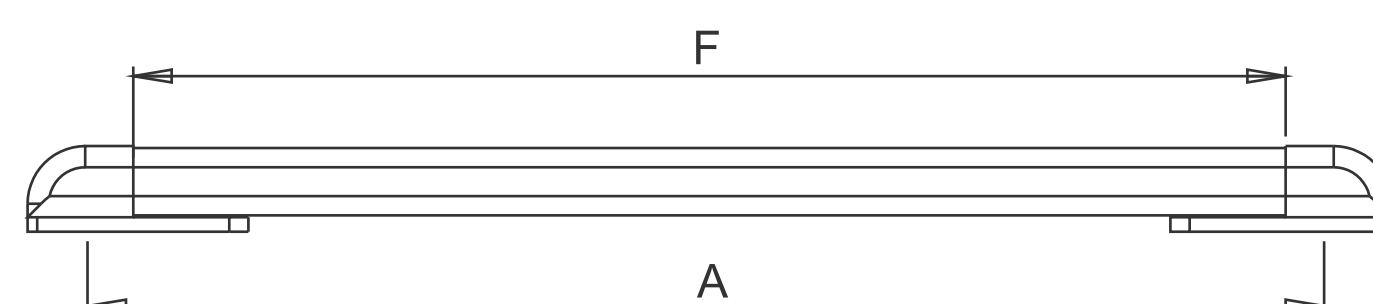
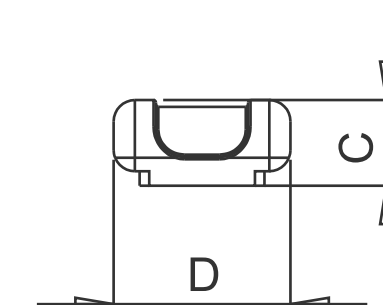

Código	A	B	C	D	E	F	G	Chapa
50592	160	174	9	18,4	---	154	---	15mm 18mm

*DIMENSÕES EM MILÍMETROS (mm) / IMAGENS E ACABAMENTOS MERAMENTE ILUSTRATIVOS.

akeo.com.br



Anodizado Natural
/ Prata

Anodizado Champagne
/ Champagne

Black Epóxi
/ Black

Consulte
outras opções
de acabamento.



LANÇAMENTO
Alumínio

SILKY FRONT

Perfil Puxador: 64mm a 1024mm

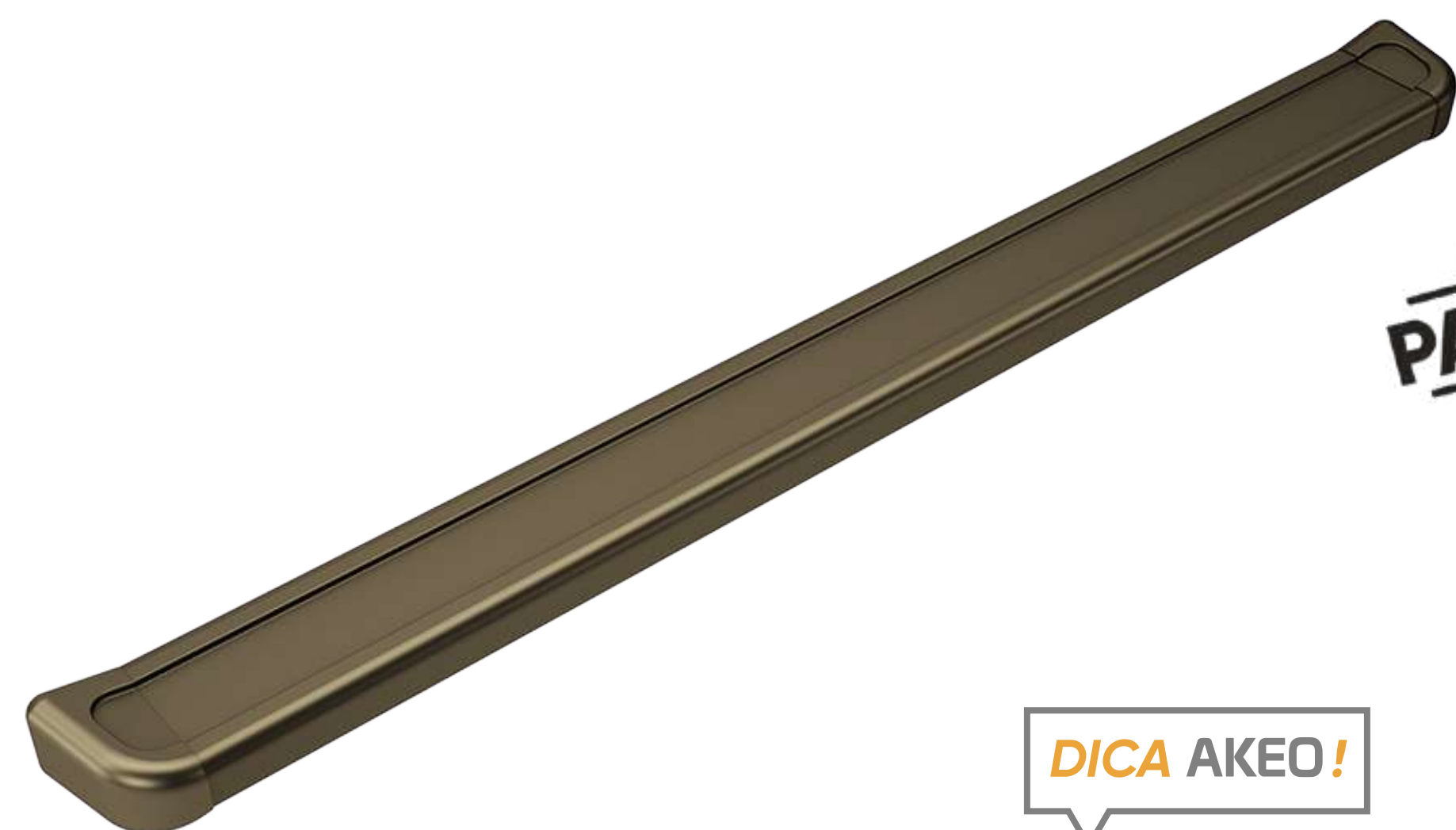

DICA AKEO!

Combine com: Puxador Silky Bas e Puxador Silky Haut.



PERFIL

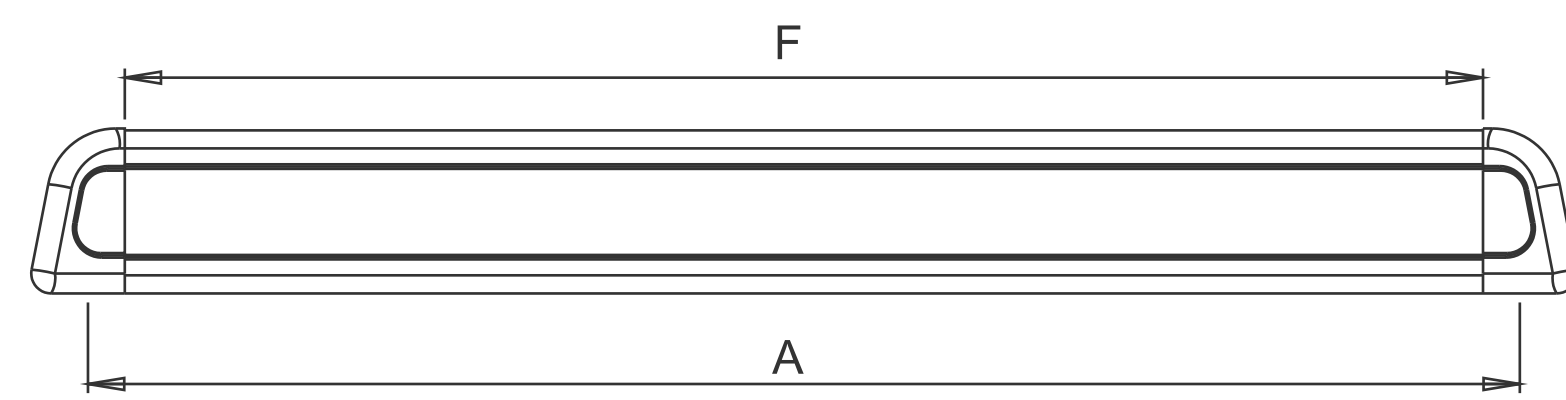
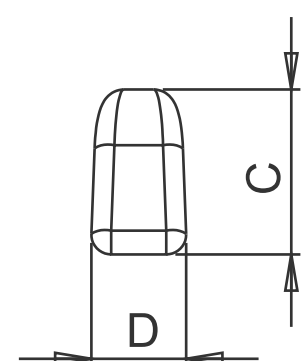

Código	A	B	C	D	E	F	G	Chapa
50591	160	170	18	10,5	---	150	---	15 / 18mm

*DIMENSÕES EM MILÍMETROS (mm) / IMAGENS E ACABAMENTOS MERAMENTE ILUSTRATIVOS.

akeo.com.br

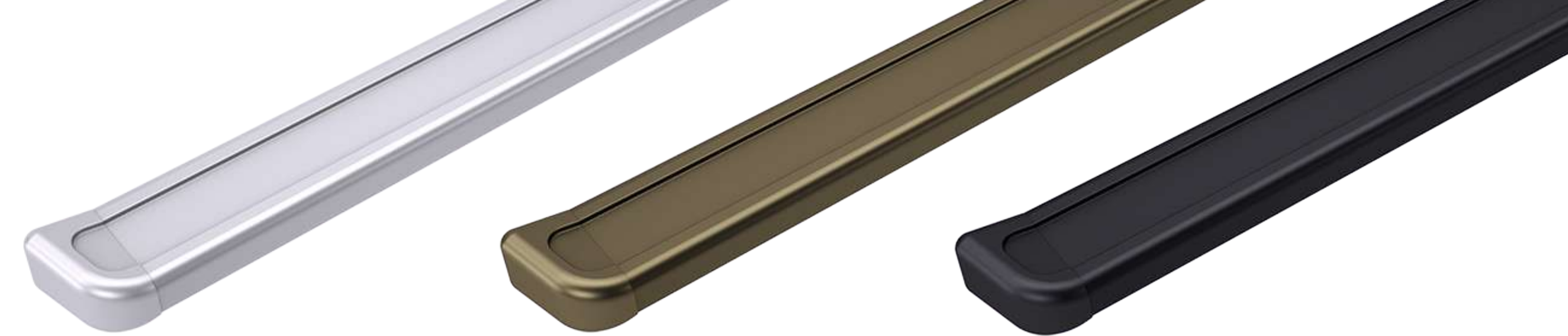

Anodizado Natural
/ Prata

Anodizado Champagne
/ Champagne

Black Epóxi
/ Black

Consulte
outras opções
de acabamento.





PUX. SILKY FRONT
ANOD. CHAMPAGNE

PUX. SILKY FRONT

FAMÍLIA SILKY

PUX. SILKY BAS
ANOD. CHAMPAGNE

PUX. SILKY HAUT
ANOD. CHAMPAGNE

PUX. SILKY FRONT
ANOD. CHAMPAGNE



SNOW

Alça: 160mm a 704mm

Acabamentos: Anodizado Natural

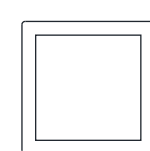
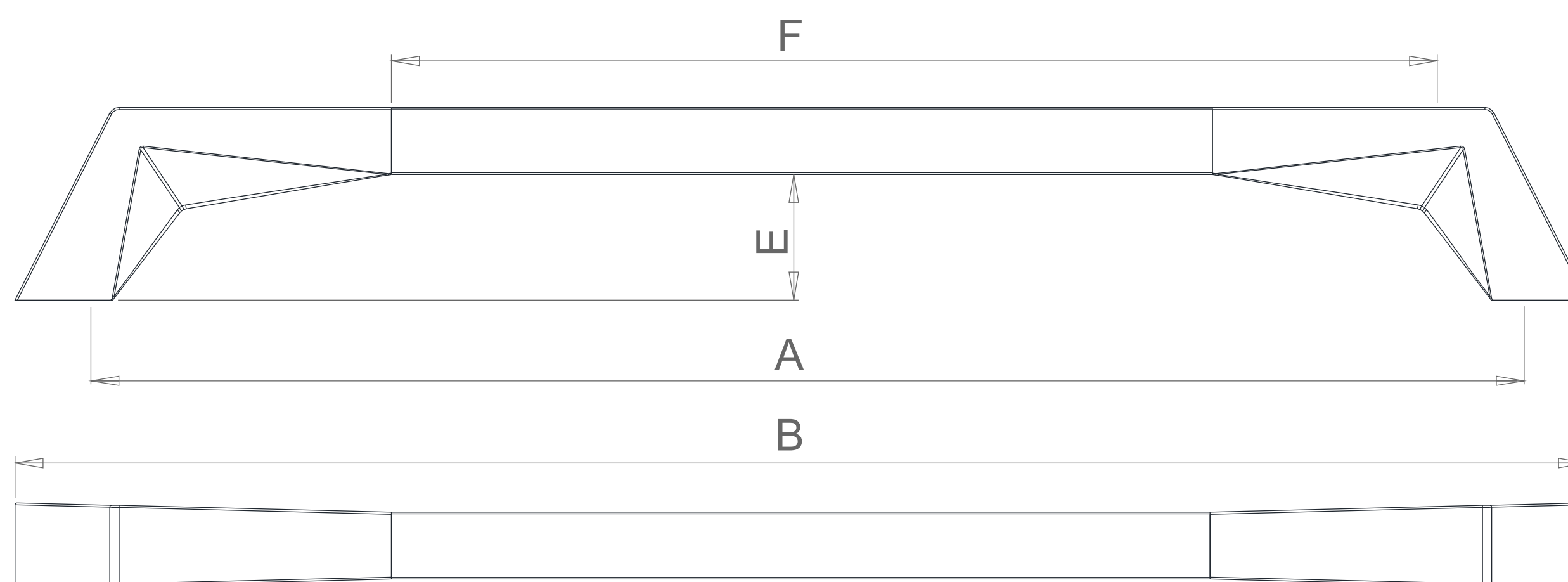
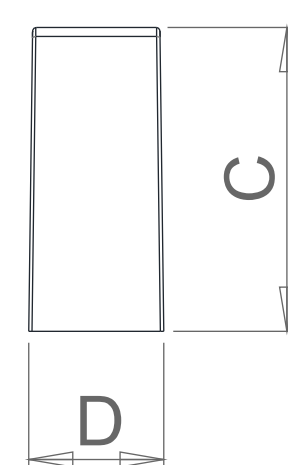

PERFIL

Código	A	B	C	D	E	F	Chapa
50819	160	182	28	12	18	74	15 / 18mm

*DIMENSÕES EM MILÍMETROS (mm) / IMAGENS E ACABAMENTOS MERAMENTE ILUSTRATIVOS.

TEDY

Alça: 128mm a 640mm

Acabamentos: Anodizado Natural

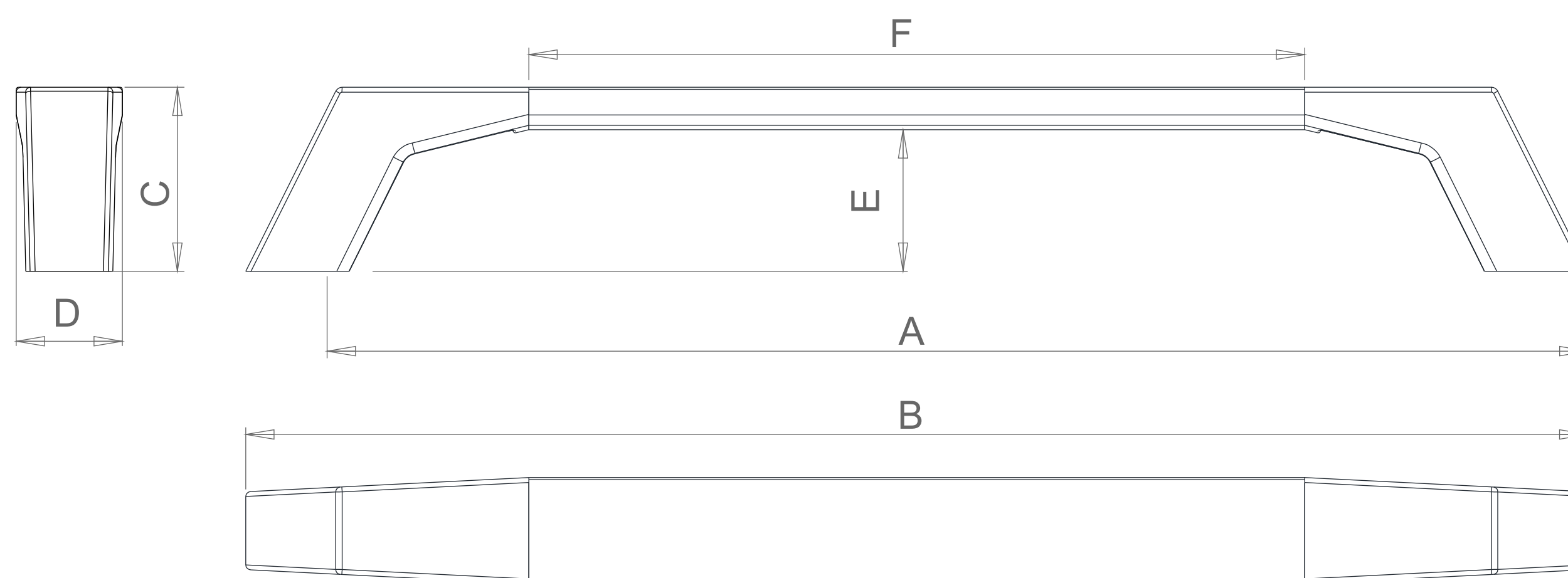

PERFIL

Código	A	B	C	D	E	F	Chapa
50580	160	183	26	15	20	103	15 / 18mm

*DIMENSÕES EM MILÍMETROS (mm) / IMAGENS E ACABAMENTOS MERAMENTE ILUSTRATIVOS.

PUXADORES

TOPO

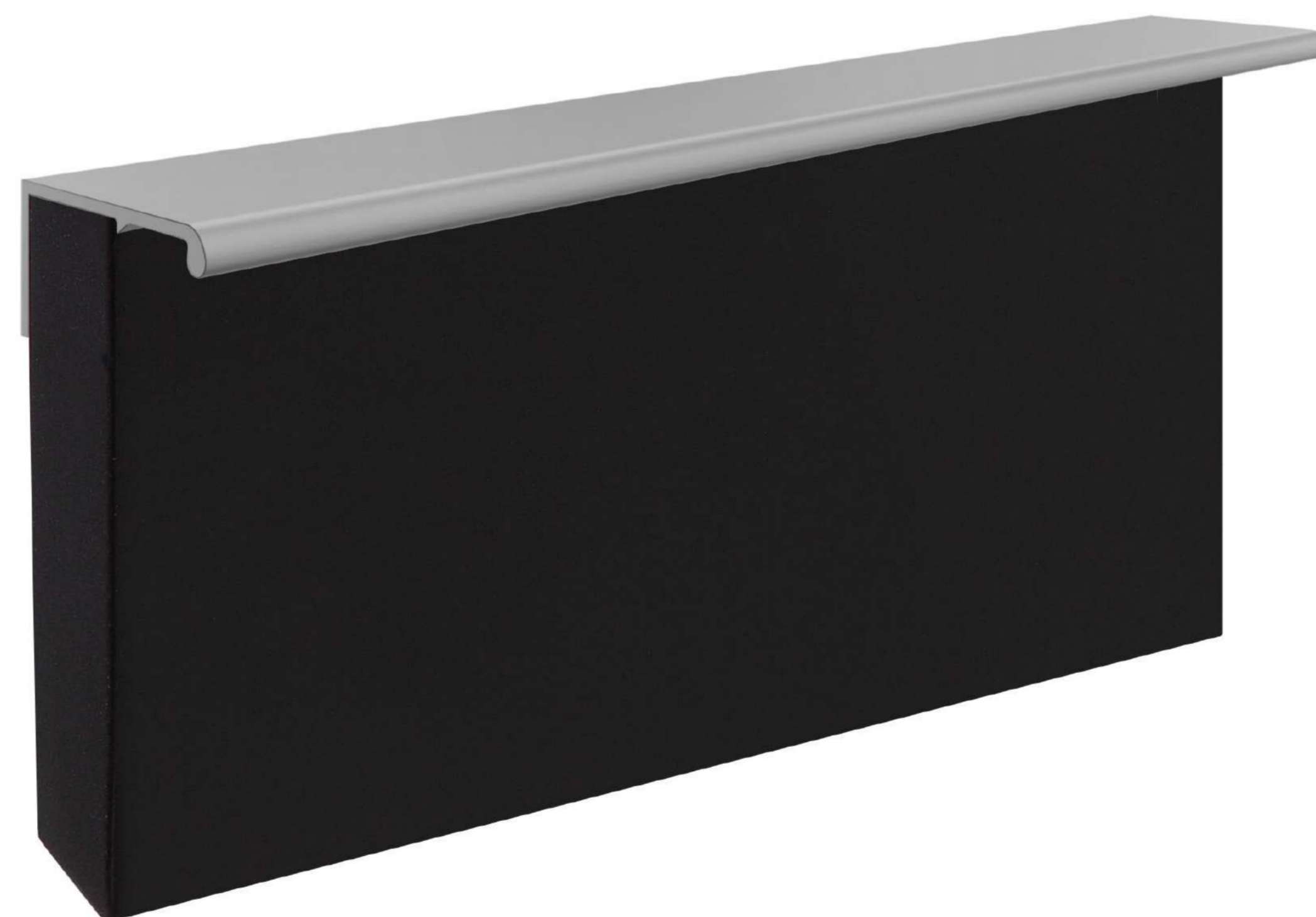

ALKEO

BALY

Perfil de Topo: Dimensão sob consulta.

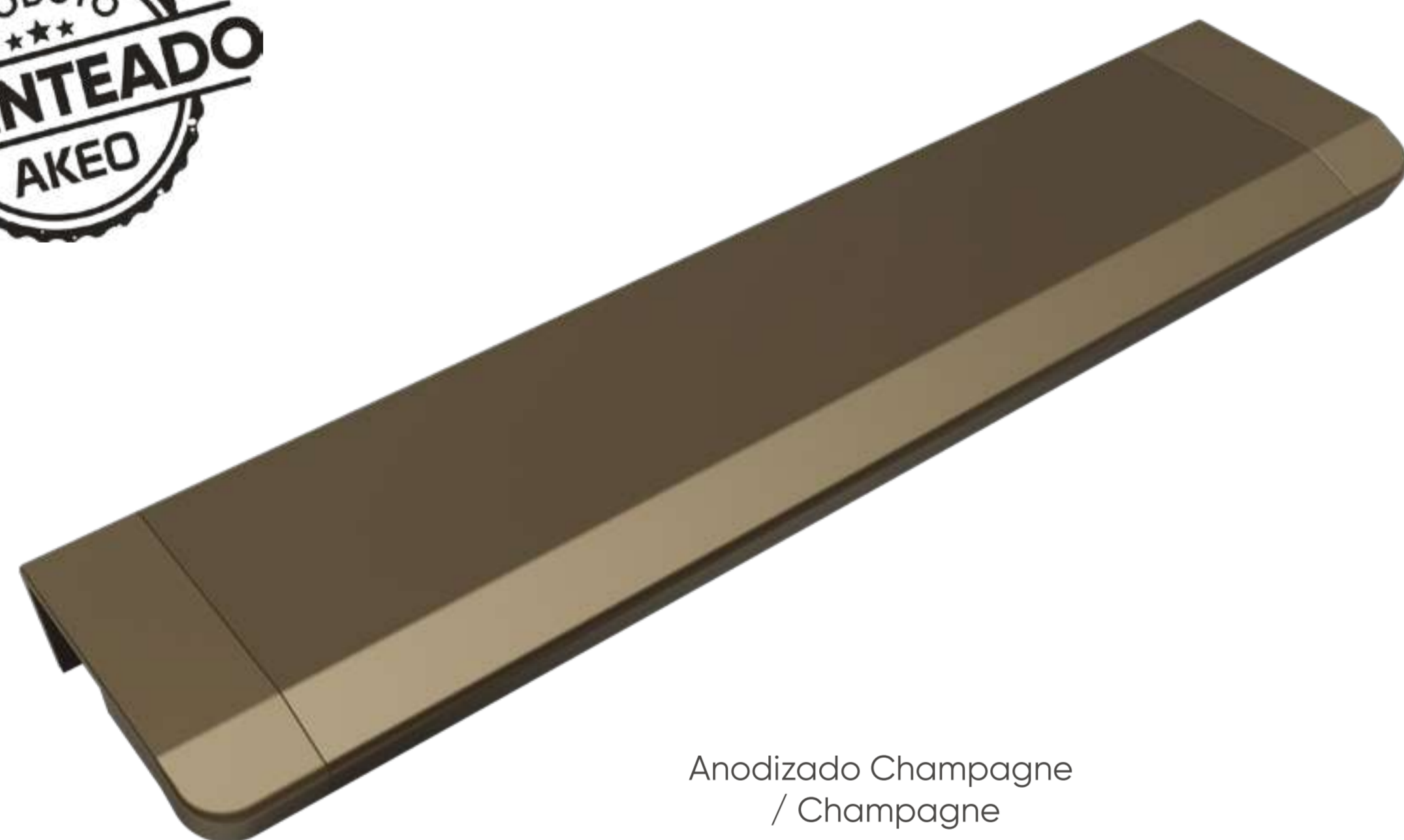

Anodizado Champagne / Champagne

Anodizado Natural / Prata

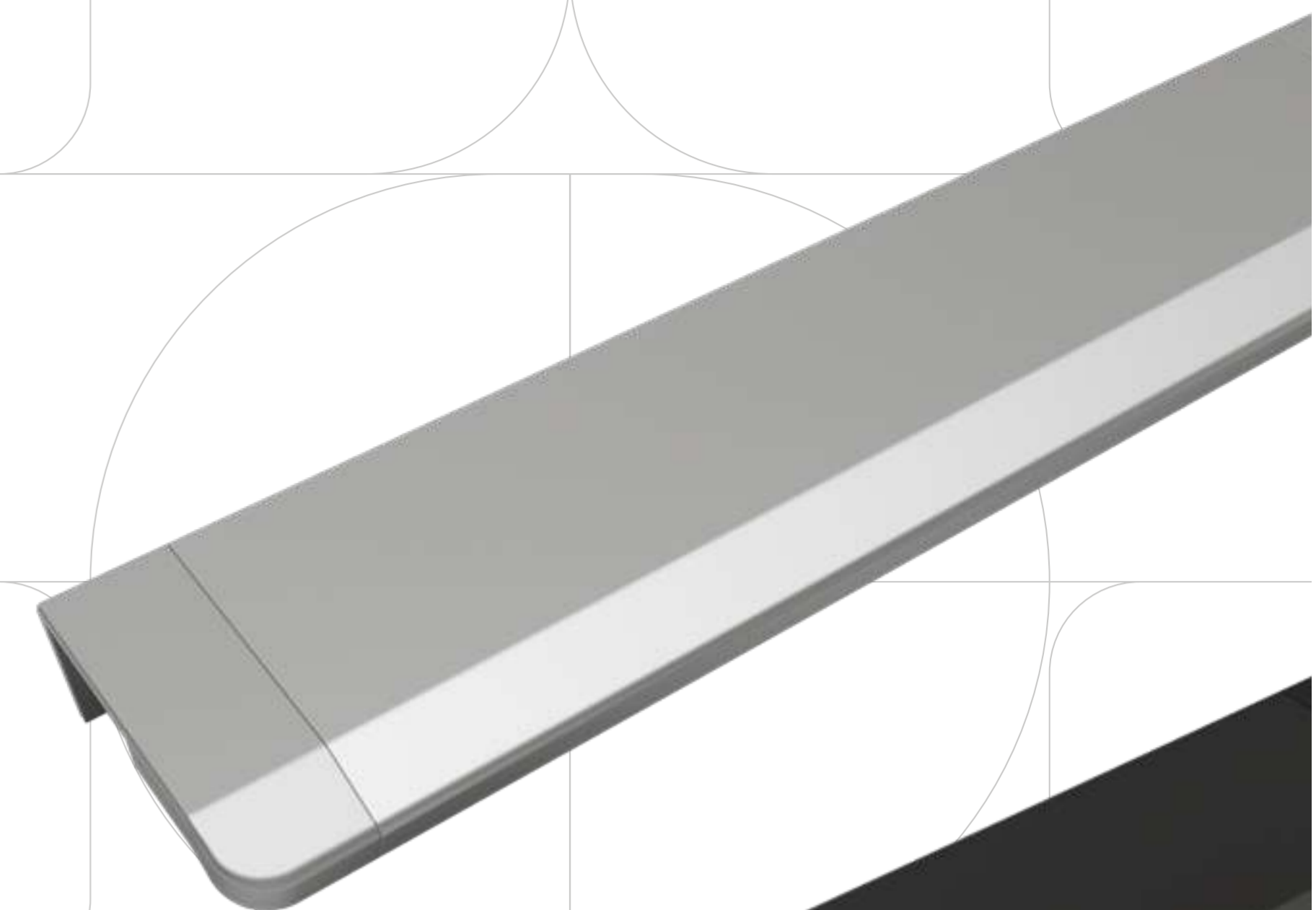

Black Epóxi / Black



Consulte outras opções de acabamento.

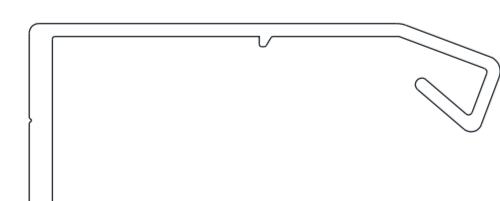
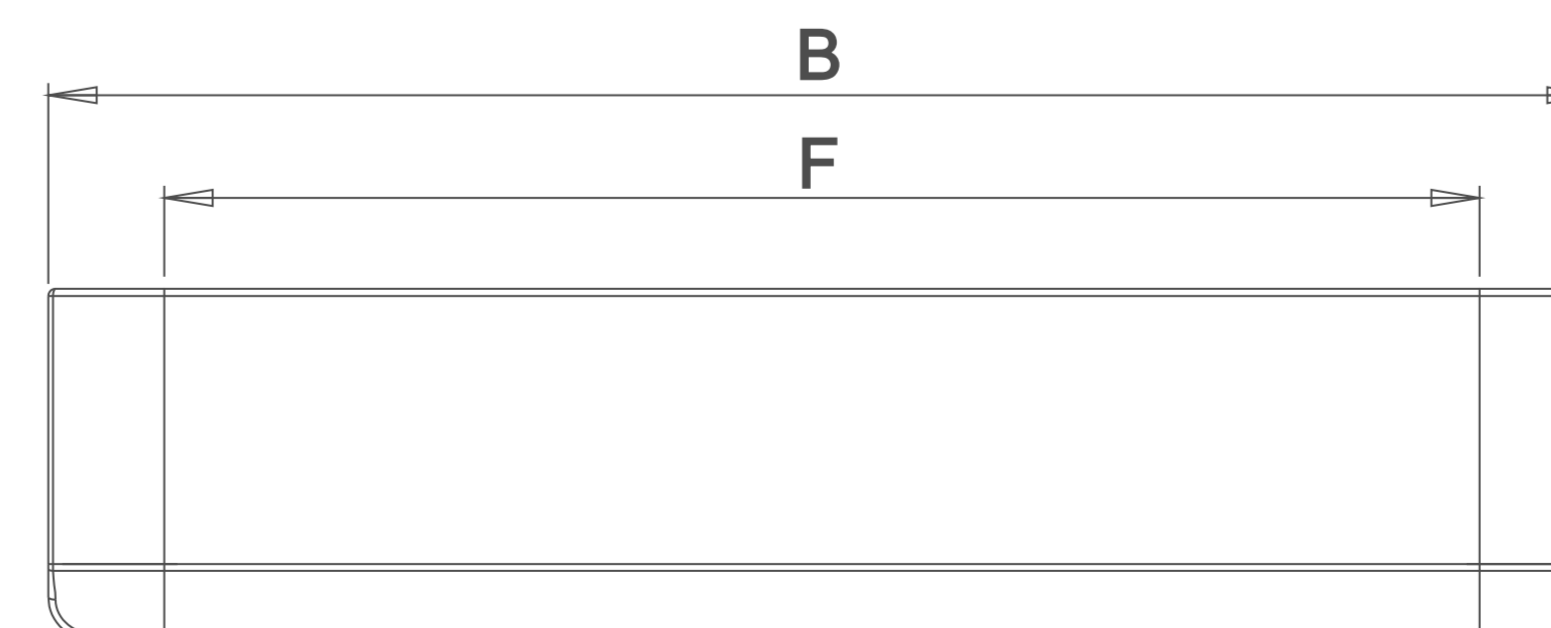
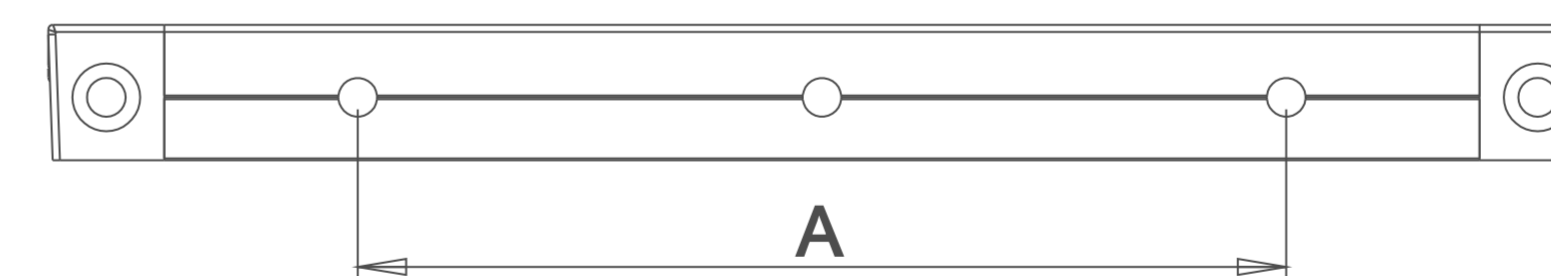
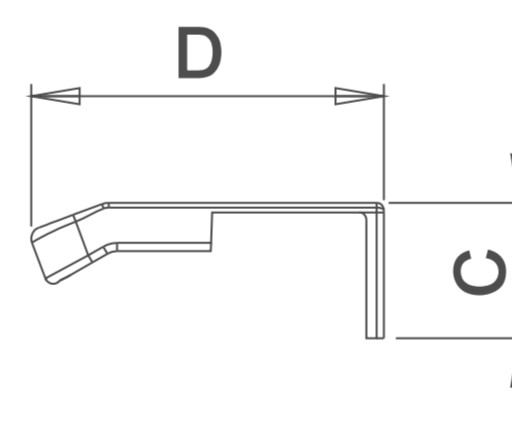

PERFIL

Código	A _{máx.}	A _{mín.}	B _{máx.}	B _{mín.}	C	D	E	F _{máx.}	F _{mín.}	Chapa
50820	768	única central	880	94	14	36,5	---	856	70	15mm

*DIMENSÕES EM MILÍMETROS (mm) / IMAGENS E ACABAMENTOS MERAMENTE ILUSTRATIVOS.

MARIS

Perfil de Topo: Dimensão sob consulta.

Acabamentos: Anodizado Natural

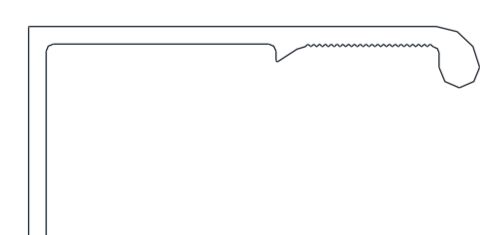
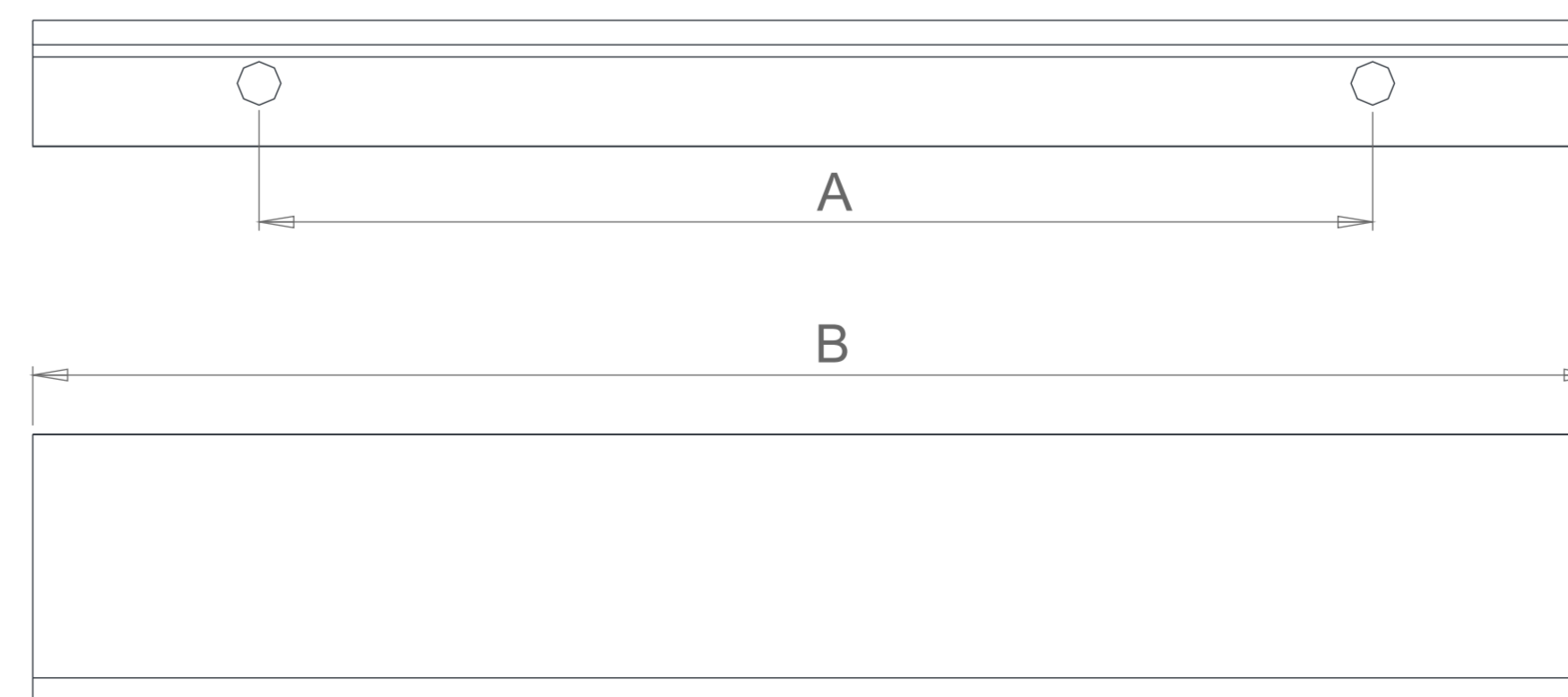
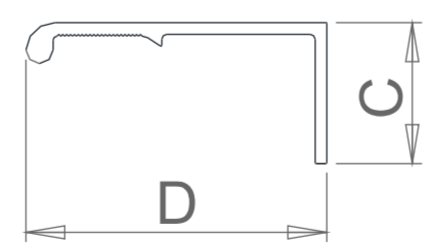
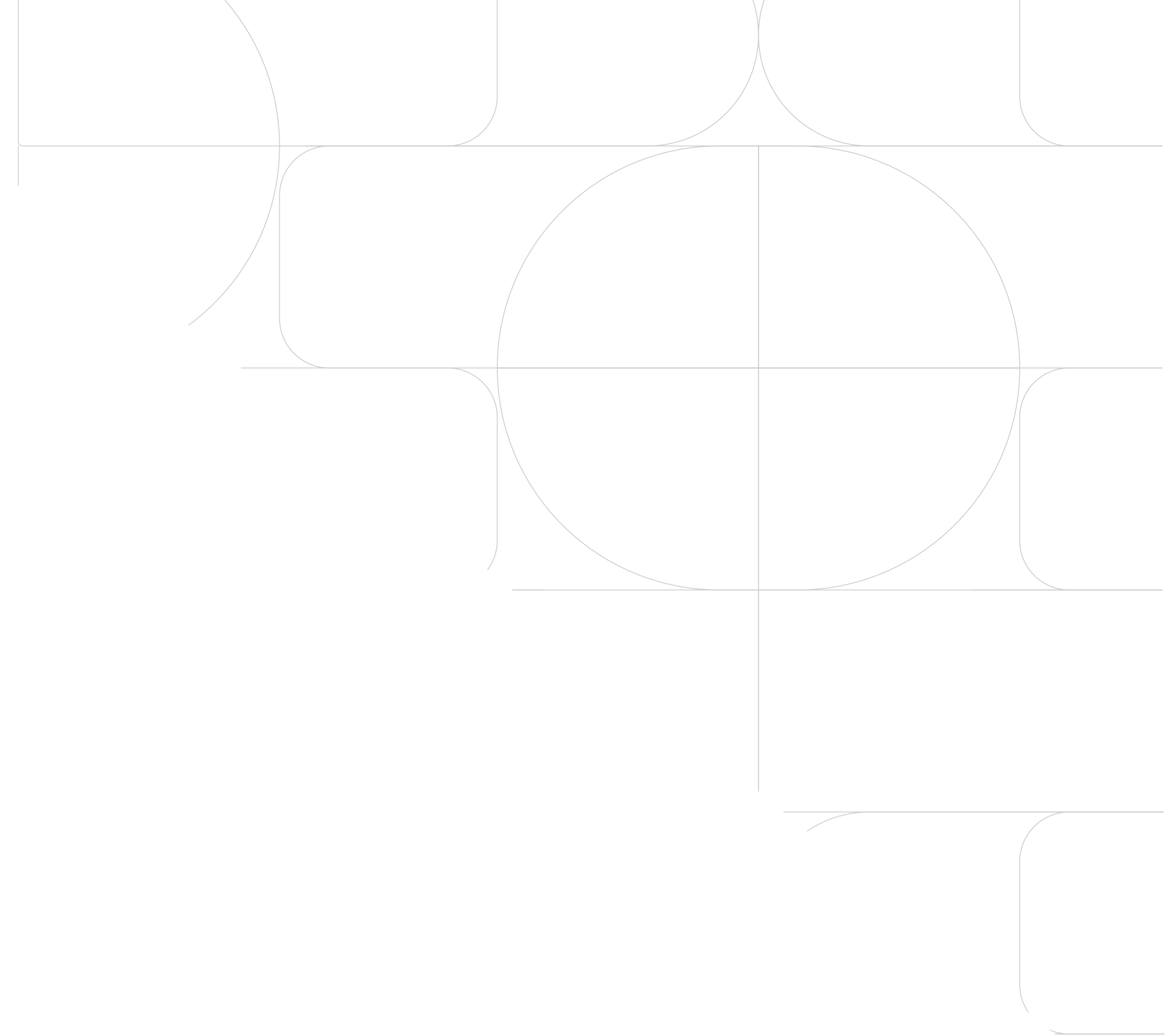

PERFIL

Código	A	B	C	D	E	F	Chapa
50682	160	128	15	7	-	-	15mm

*DIMENSÕES EM MILÍMETROS (mm) / IMAGENS E ACABAMENTOS MERAMENTE ILUSTRATIVOS.

NIS

Perfil de Topo: Dimensão sob consulta.



Anodizado Champagne / Champagne

Consulte outras opções de acabamento.



Anodizado Natural / Prata



Black Epóxi / Black

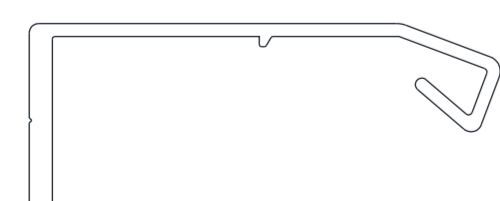
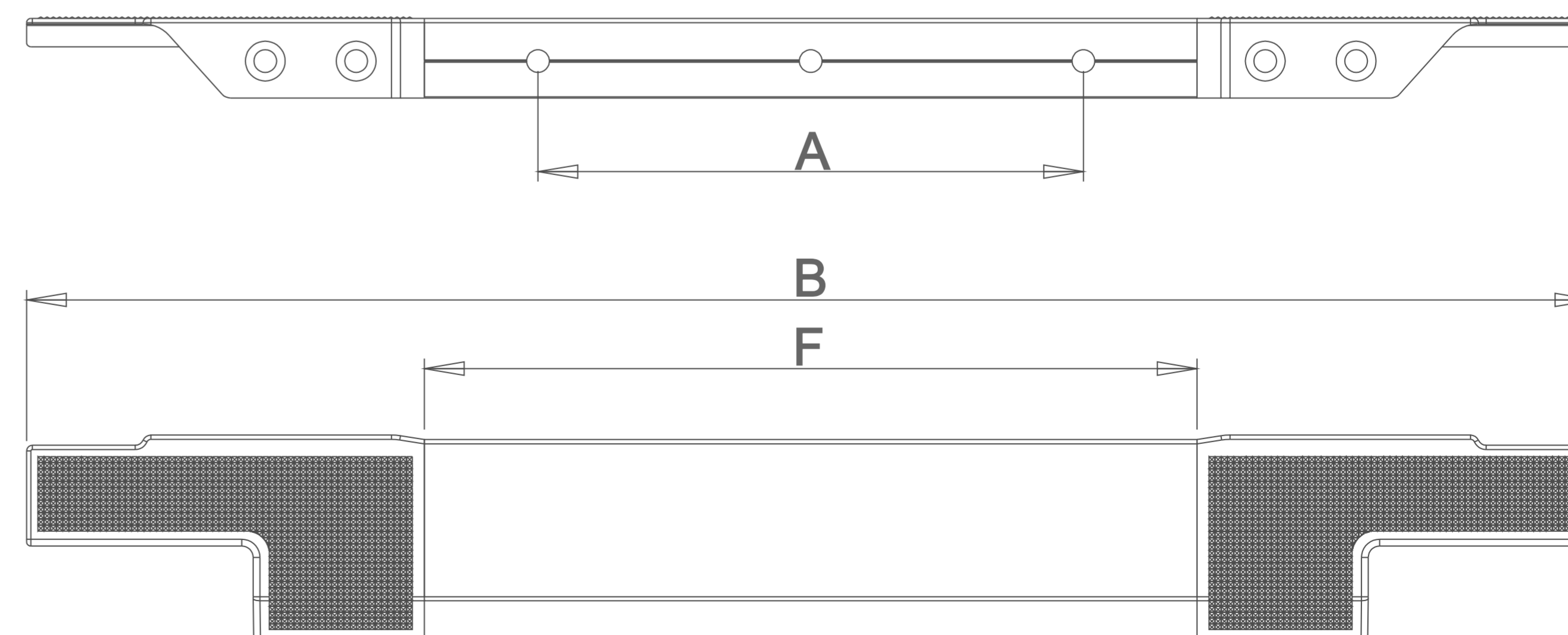
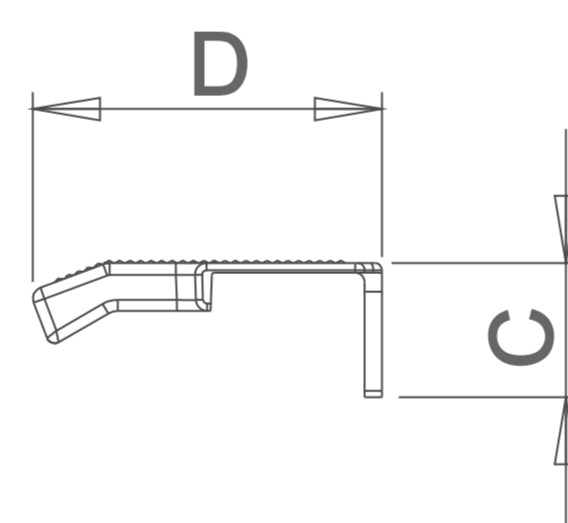

PERFIL

Código	A _{máx.}	A _{mín.}	B _{máx.}	B _{mín.}	C	D	E	F _{máx.}	F _{mín.}	Chapa
50805	768	única central	996	210	14	36,5	---	856	70	15mm

*DIMENSÕES EM MILÍMETROS (mm) / IMAGENS E ACABAMENTOS MERAMENTE ILUSTRATIVOS.



VÍDEO
AKEO

MAIS INFORMAÇÕES
SOBRE O PRODUTO
ACESSE O QR CODE

PUX. NIS

PUXADORES PERFIS



ATHOS BAS

Perfil Puxador: 64mm a 992mm

Acabamentos: Anodizado Natural, Anodizado Champagne e Black Epóxi.



DICA AKEO!

Combine com: Puxador Athos Haut e Puxador Athos Courbe.



PERFIL

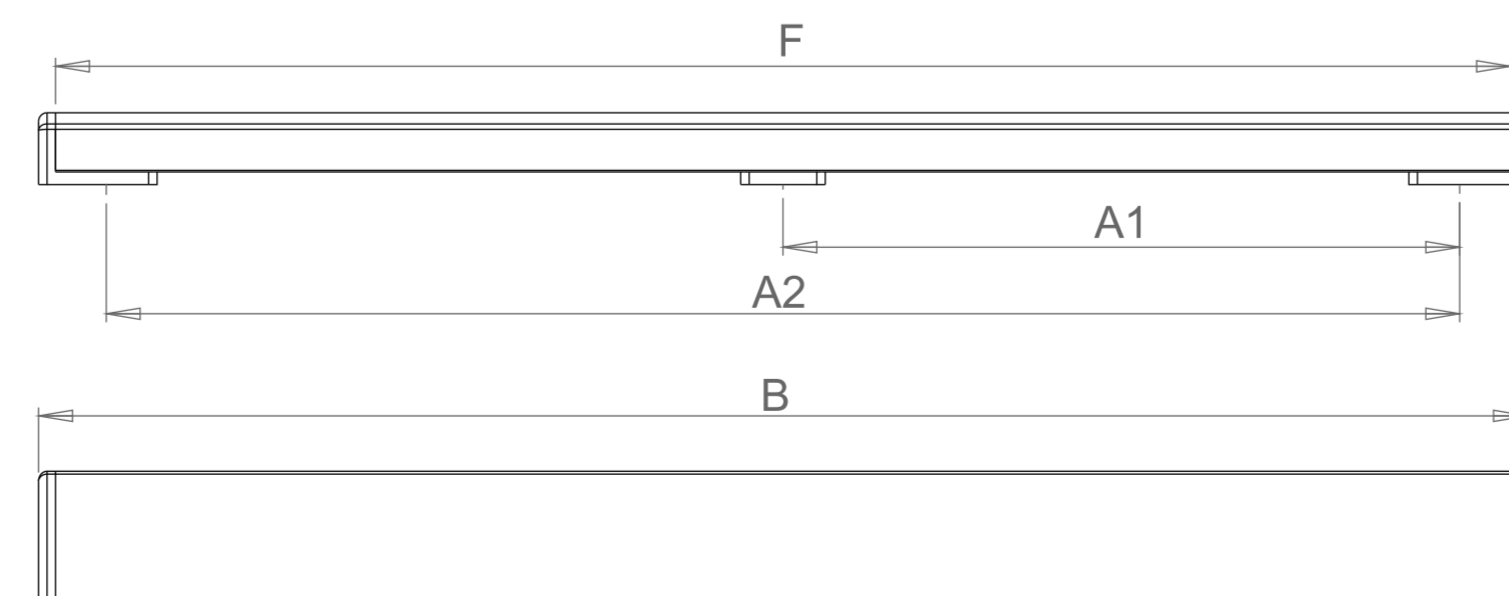
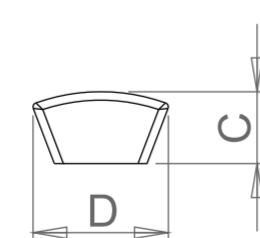

Código	A1	A2	B	C	D	E	F	Chapa
50131	80	160	176	9	16	-	172	15 / 18mm

*DIMENSÕES EM MILÍMETROS (mm) / IMAGENS E ACABAMENTOS MERAMENTE ILUSTRATIVOS.



BONAIRE

Perfil Puxador: 96mm a 1536mm

Acabamentos: Anodizado Natural e Anodizado Champagne.

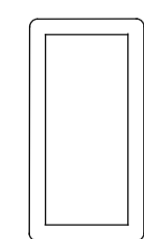

PERFIL

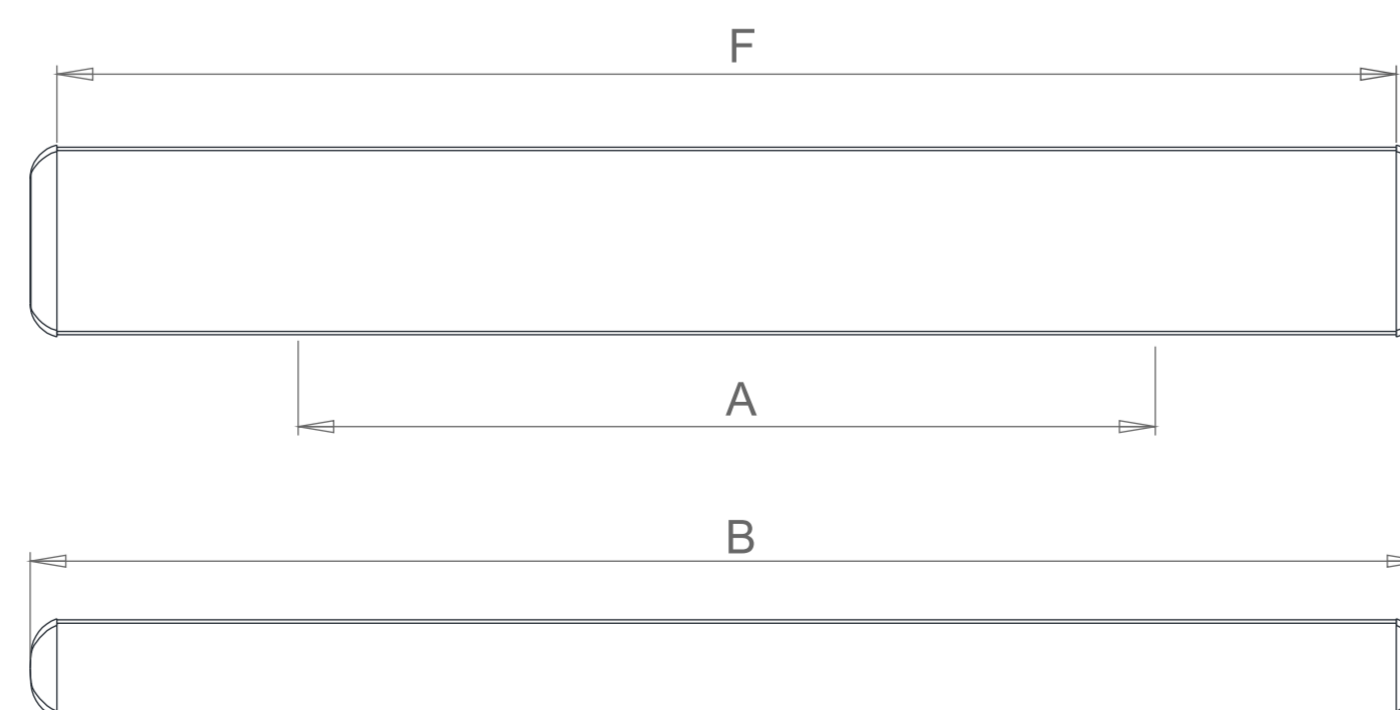
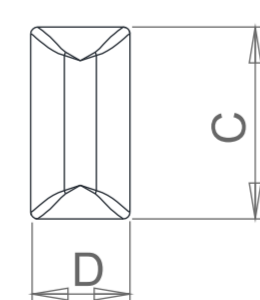

Código	A	B	C	D	E	F	Chapa
50775	64	104	14	7	-	100	15 / 18mm

*DIMENSÕES EM MILÍMETROS (mm) / IMAGENS E ACABAMENTOS MERAMENTE ILUSTRATIVOS.

akeo.com.br



MINIÁPOLIS

Perfil Puxador: 96mm a 992mm

Acabamentos: Anodizado Natural e Anodizado Champagne.

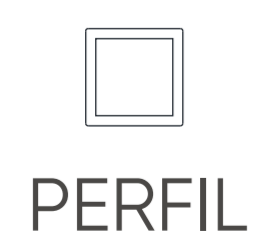
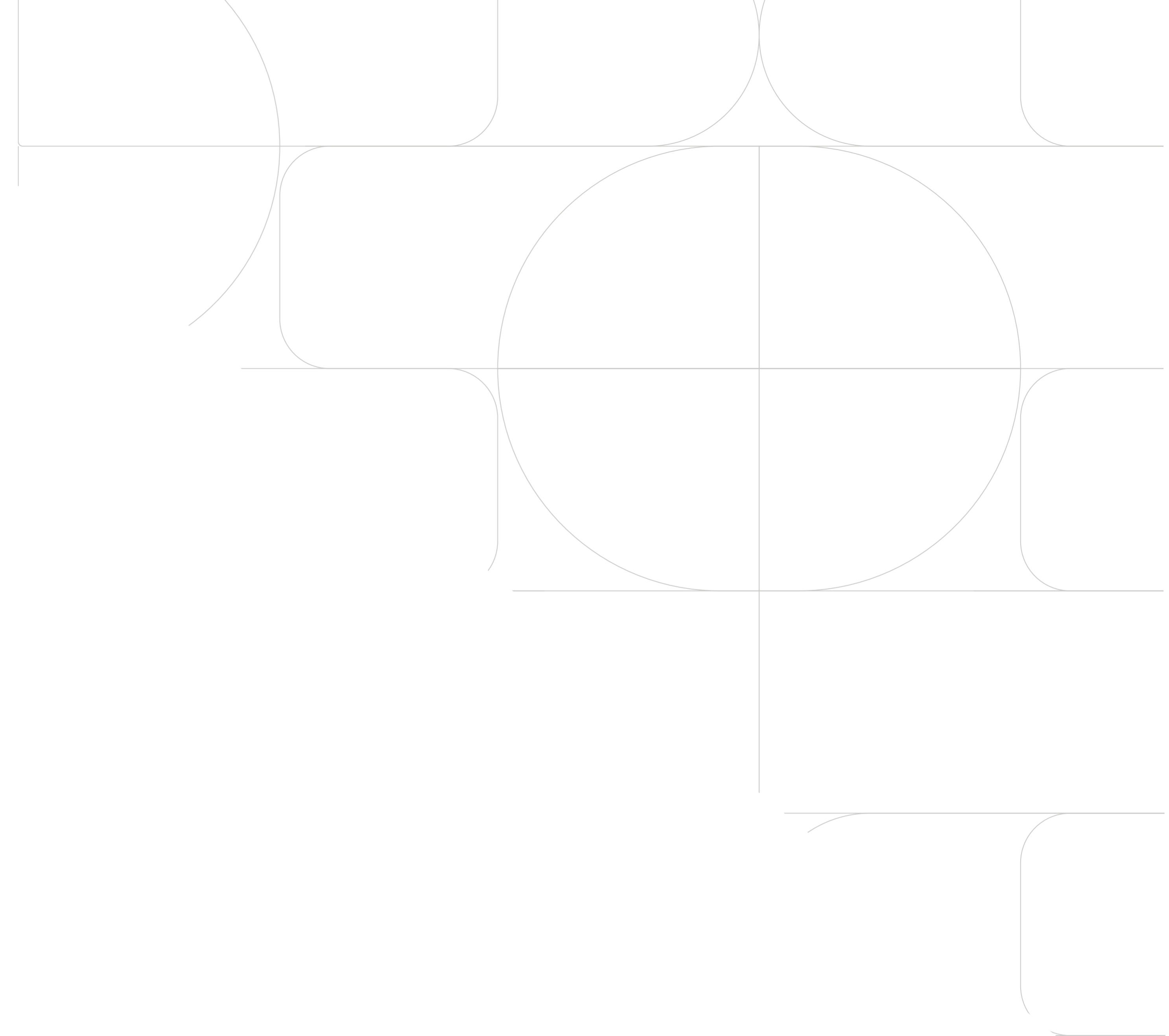

PERFIL

Código	A	B	C	D	E	F	Chapa
50722	160	204	10	10	-	200	15 / 18mm

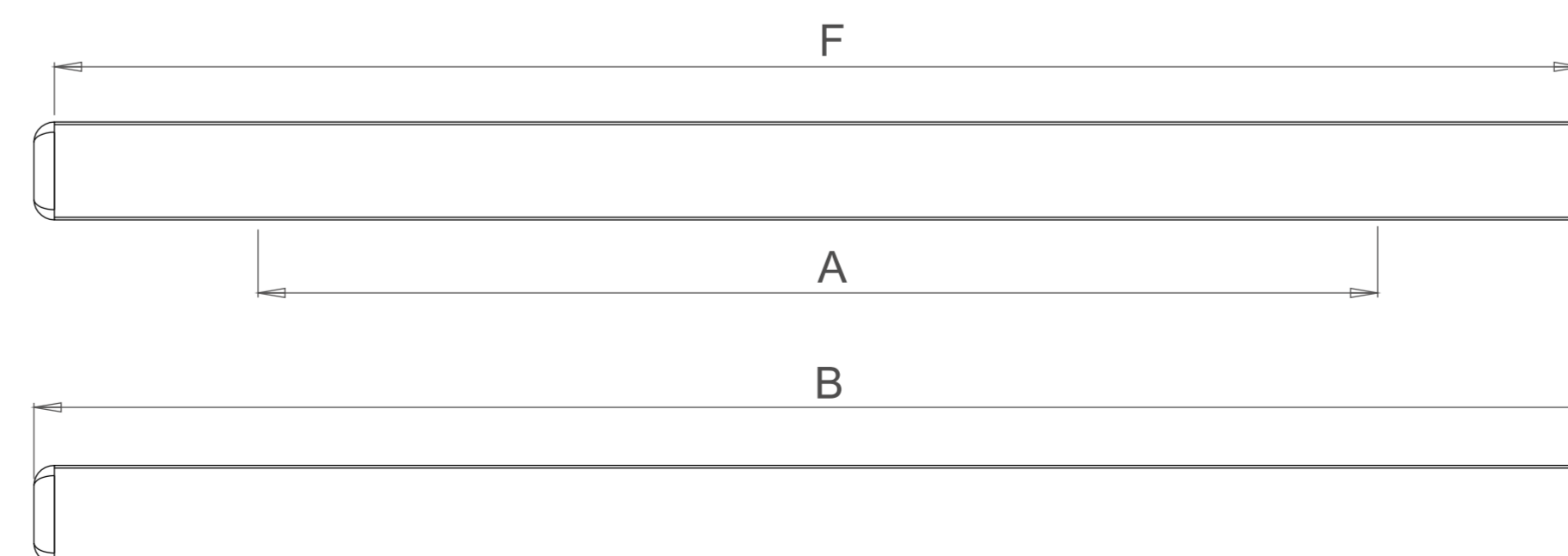
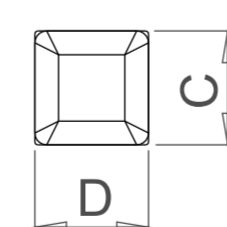

*DIMENSÕES EM MILÍMETROS (mm) / IMAGENS E ACABAMENTOS MERAMENTE ILUSTRATIVOS.

akeo.com.br

LANÇAMENTO
Alumínio

SILKY BAS

Perfil Puxador: 96mm a 512mm



DICA AKEO!

Combine com: Puxador Silky Haut e Puxador Silky Front.

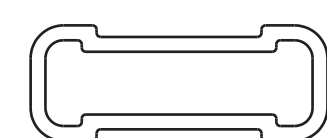

PERFIL

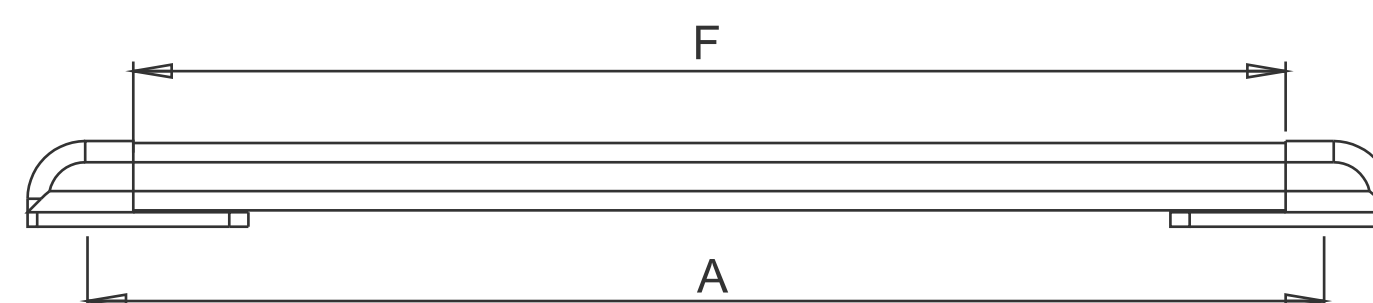
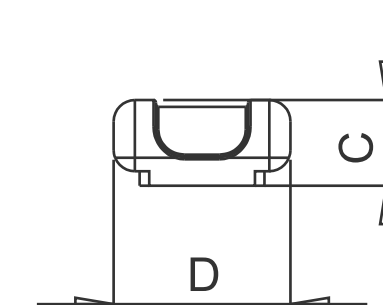

Código	A	B	C	D	E	F	G	Chapa
50592	160	174	9	18,4	---	154	---	15mm 18mm

*DIMENSÕES EM MILÍMETROS (mm) / IMAGENS E ACABAMENTOS MERAMENTE ILUSTRATIVOS.

akeo.com.br



Anodizado Natural
/ Prata

Anodizado Champagne
/ Champagne

Black Epóxi
/ Black

Consulte
outras opções
de acabamento.



LANÇAMENTO
Alumínio

SILKY FRONT

Perfil Puxador: 64mm a 1024mm

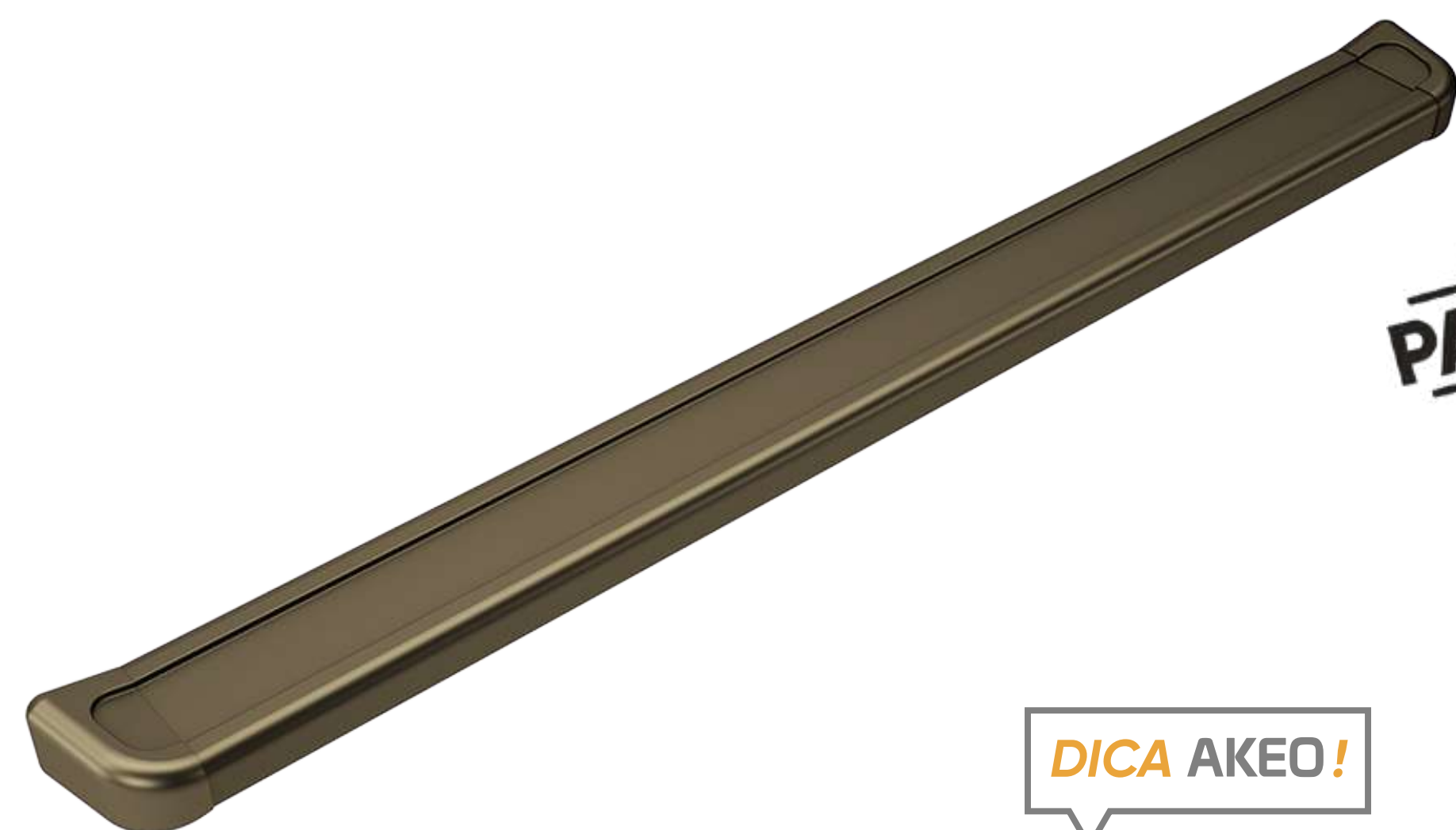

DICA AKEO!

Combine com: Puxador Silky Bas e Puxador Silky Haut.



PERFIL

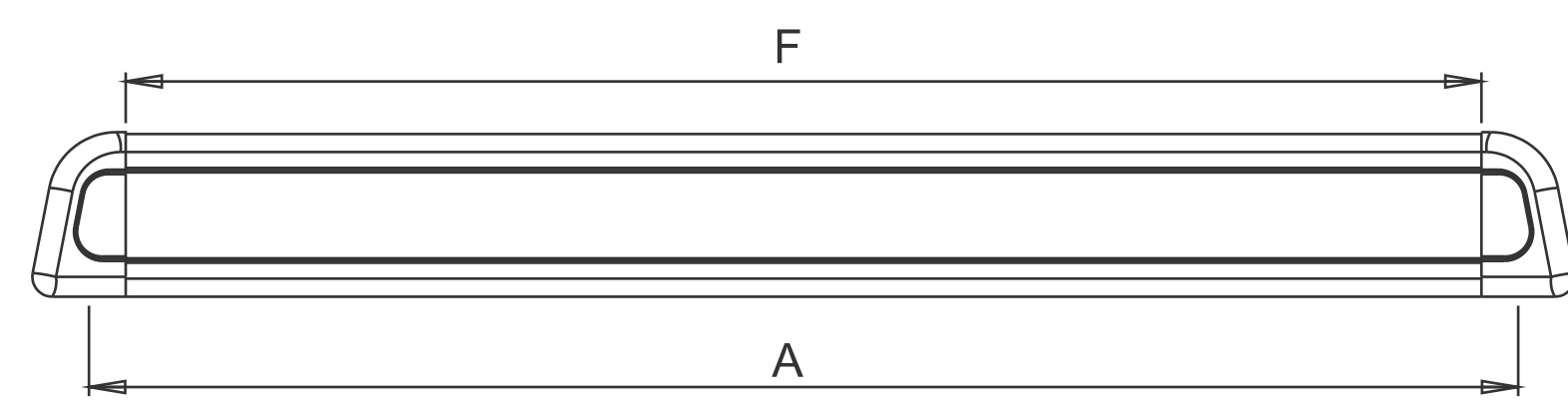
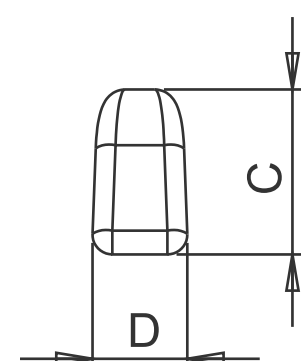

Código	A	B	C	D	E	F	G	Chapa
50591	160	170	18	10,5	---	150	---	15 / 18mm

*DIMENSÕES EM MILÍMETROS (mm) / IMAGENS E ACABAMENTOS MERAMENTE ILUSTRATIVOS.

akeo.com.br

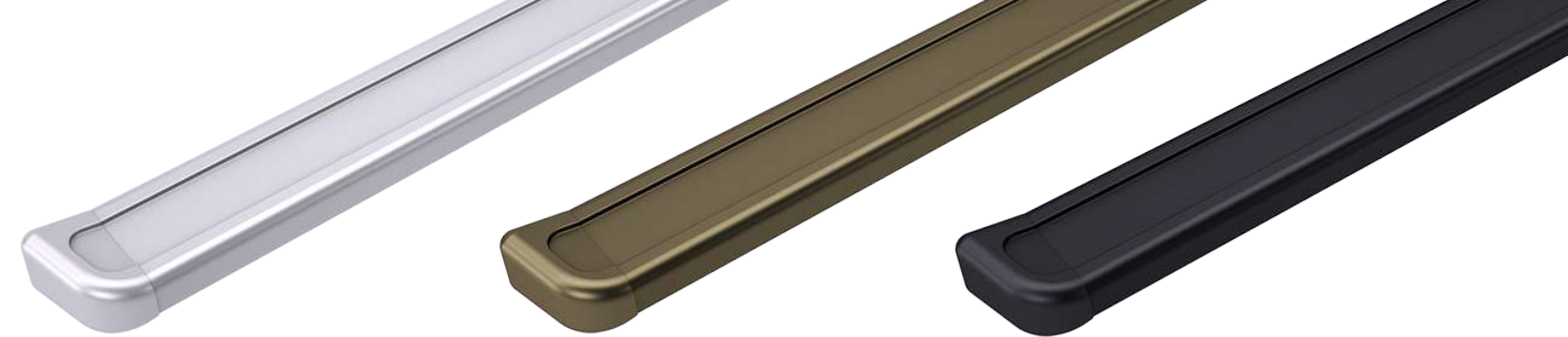

Anodizado Natural
/ Prata

Anodizado Champagne
/ Champagne

Black Epóxi
/ Black

Consulte
outras opções
de acabamento.





VÍDEO
AKEO

MAIS INFORMAÇÕES
SOBRE O PRODUTO
ACESSE O QR CODE

PUX. SILKY FRONT
ANOD. CHAMPAGNE

PUX. SILKY FRONT
ANOD. CHAMPAGNE

PUX. SILKY BAS
ANOD. CHAMPAGNE

PUX. SILKY FRONT E HAUT

TYDA

Perfil Puxador: 96mm a 1536mm

Acabamentos: Anodizado Natural

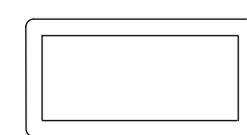

PERFIL

Código	A	B	C	D	E	F	Chapa
50776	160	166	7	14	-	192	15 / 18mm

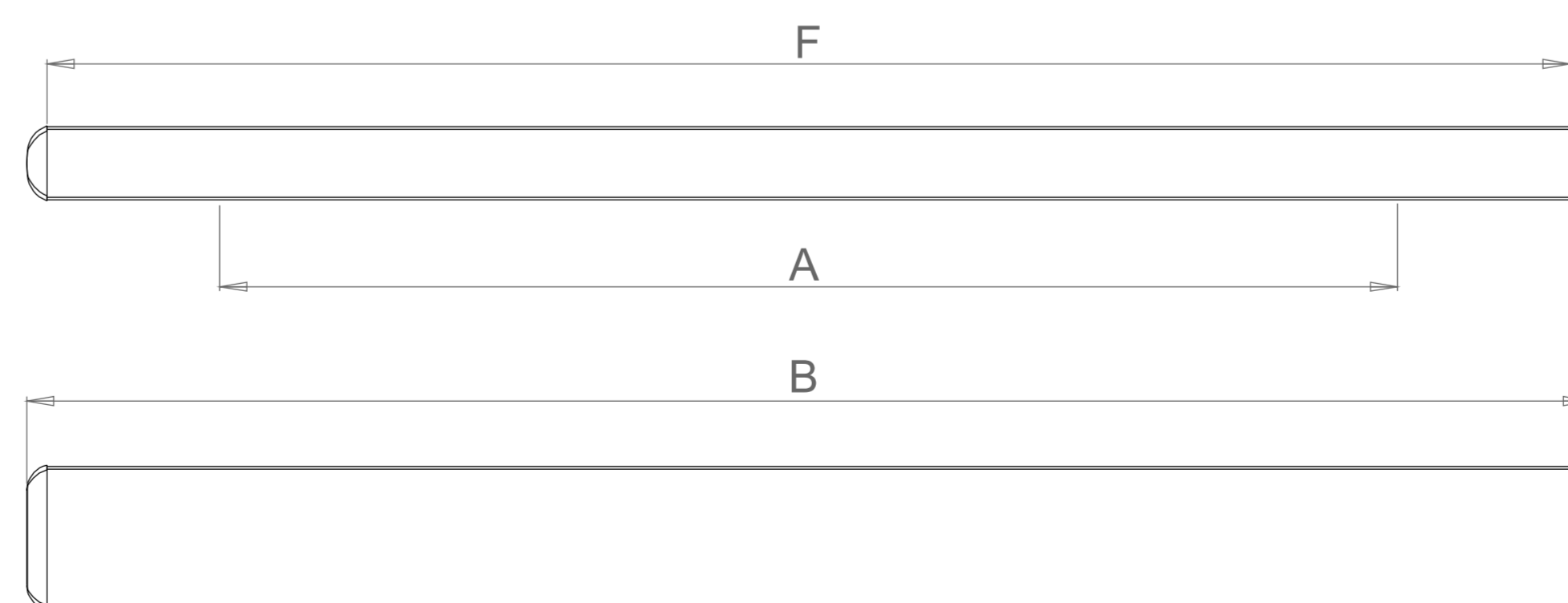
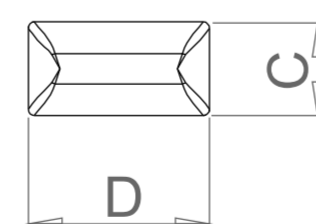

*DIMENSÕES EM MILÍMETROS (mm) / IMAGENS E ACABAMENTOS MERAMENTE ILUSTRATIVOS.

akeo.com.br

PÉS



AKEO
AKEO

ÁTILA

Pé: Altura conforme necessidade do cliente.

Acabamentos: Anodizado Natural

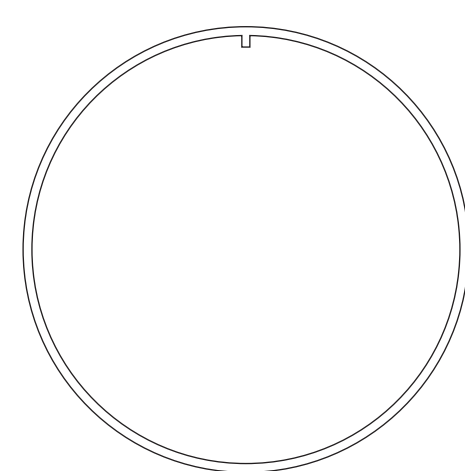
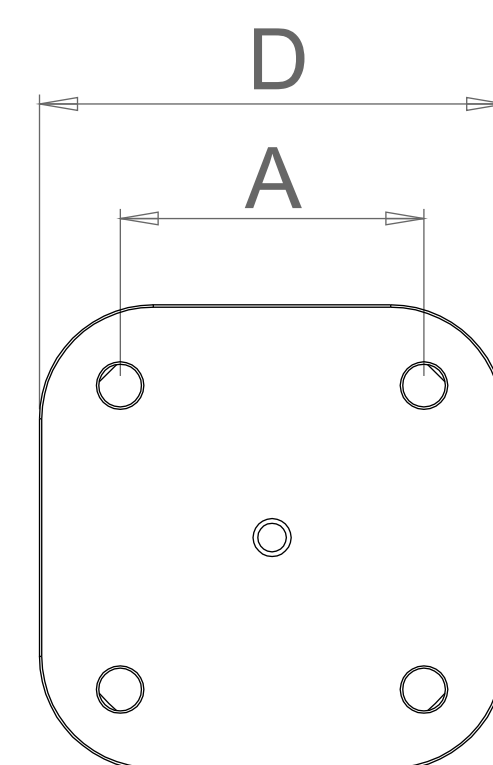
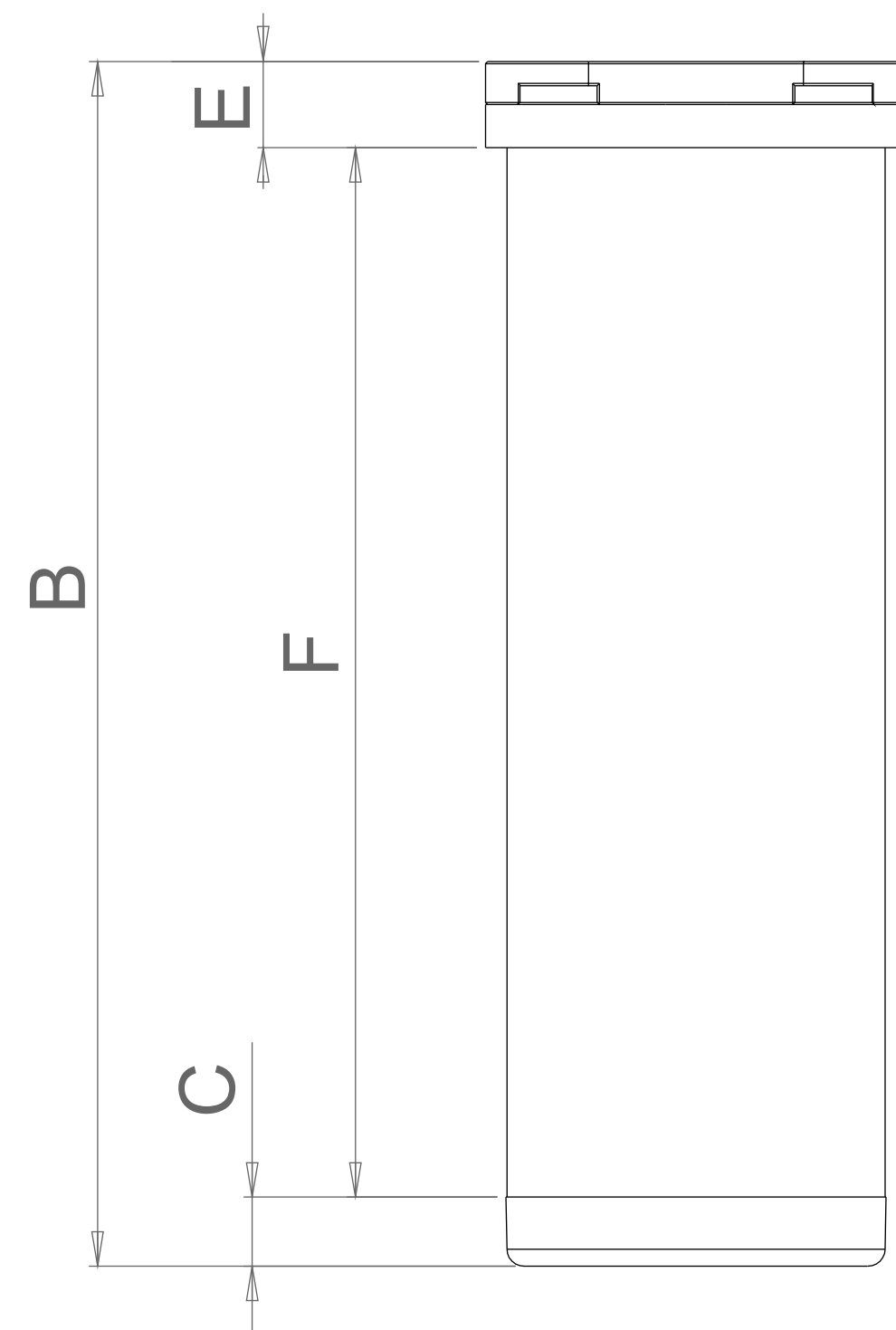

PERFIL

Código	A	B	C	D	E	F	Chapa
50677	32	140	8	49	10	122	15 / 18mm

*DIMENSÕES EM MILÍMETROS (mm) / IMAGENS E ACABAMENTOS MERAMENTE ILUSTRATIVOS.



KOLUMNY

Pé: Altura conforme necessidade do cliente.

Acabamentos: Anodizado Natural

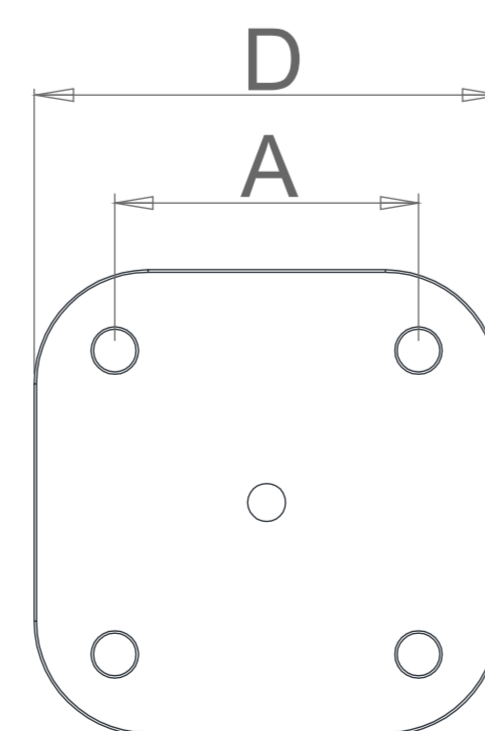
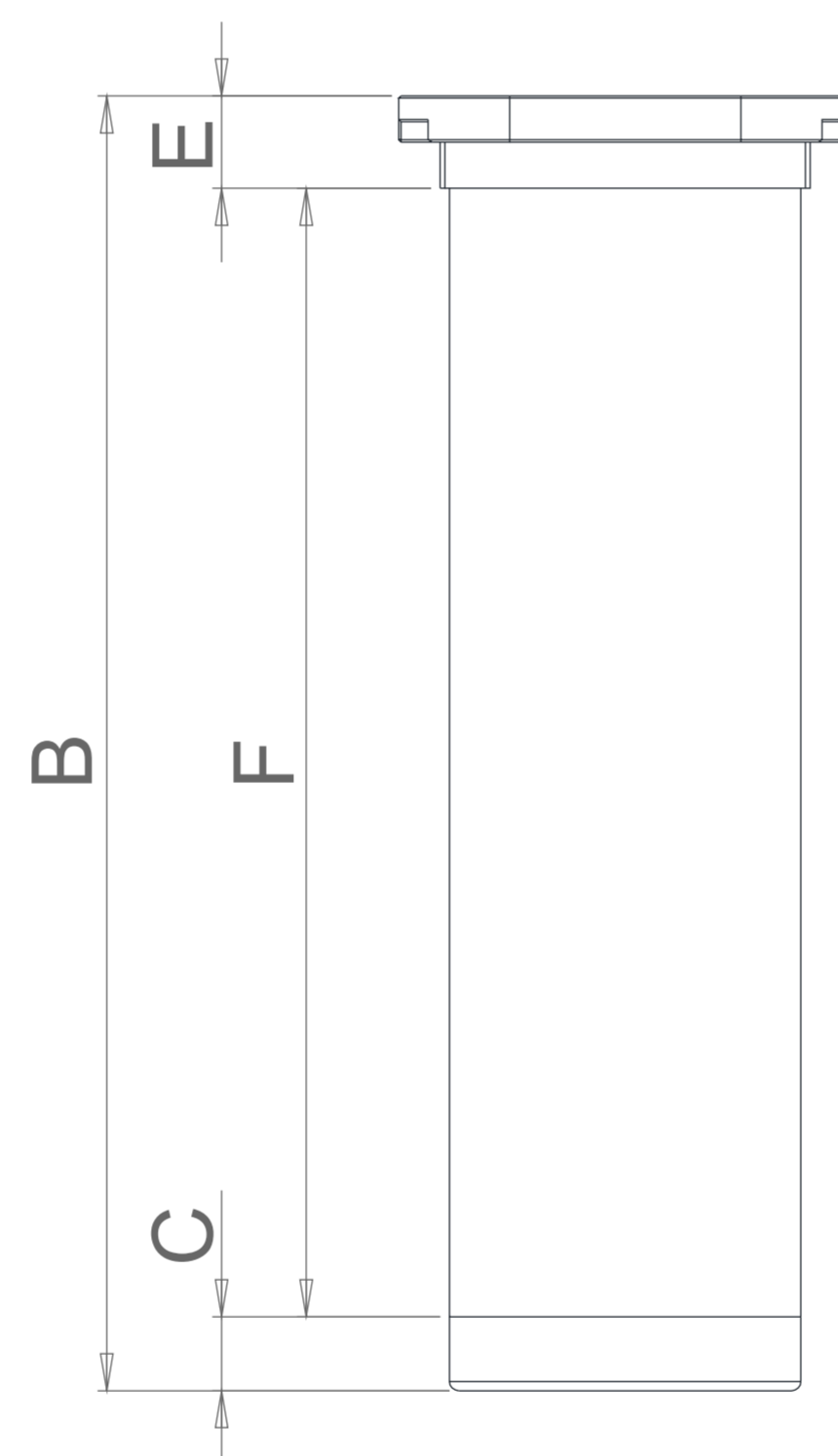

PERFIL

Código	A	B	C	D	E	F	Chapa
50673	32	140	8	49	10	122	15 / 18mm

*DIMENSÕES EM MILÍMETROS (mm) / IMAGENS E ACABAMENTOS MERAMENTE ILUSTRATIVOS.



ACABAMENTOS

INFINITAS POSSIBILIDADES DE TONALIDADES E EFEITOS.
PARA CADA PROJETO EXISTE O **ACABAMENTO IDEAL.**

PERFIS EM ALUMÍNIO



ANODIZADO NATURAL

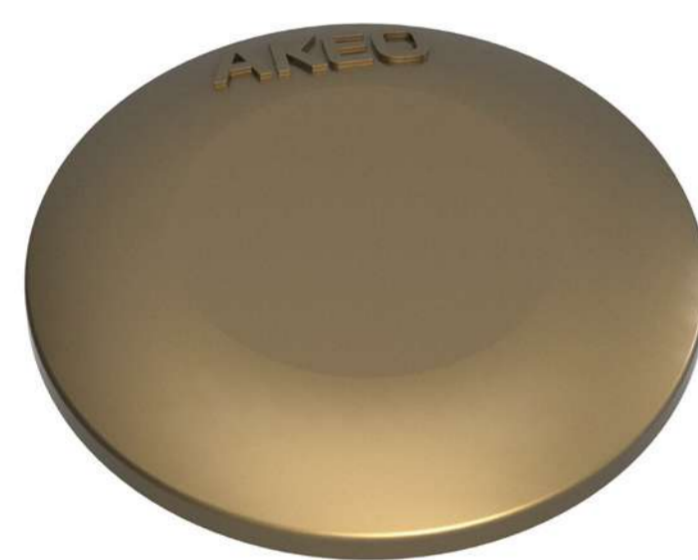

ANODIZADO CHAMPAGNE



COBRE



DOURADO



ANODIZADO INOX



BLACK EPÓXI



DAMASCO



GRAFITE

DICA AKEO!

Faça composições dos perfis com as ponteiros injetadas.
Crie contrastes ou unifique as tonalidades do acessório.

PEÇAS INJETADAS



CROMO

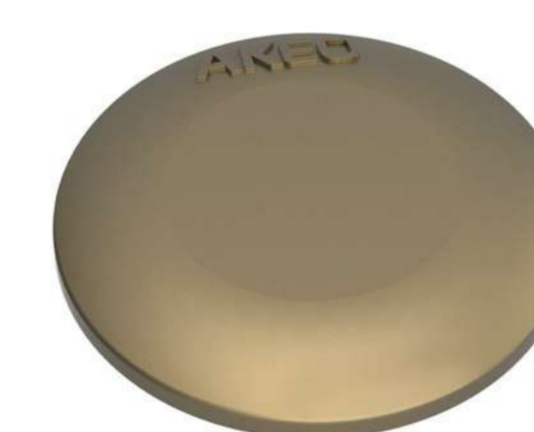

CHAMPAGNE



COBRE



STEEL



GOLD



PRATA



BLACK



ÔNIX



INOX FOSCO



ROSE GOLD FOSCO



GRAFITE



DAMASCO



OURO FOSCO



DOURADO

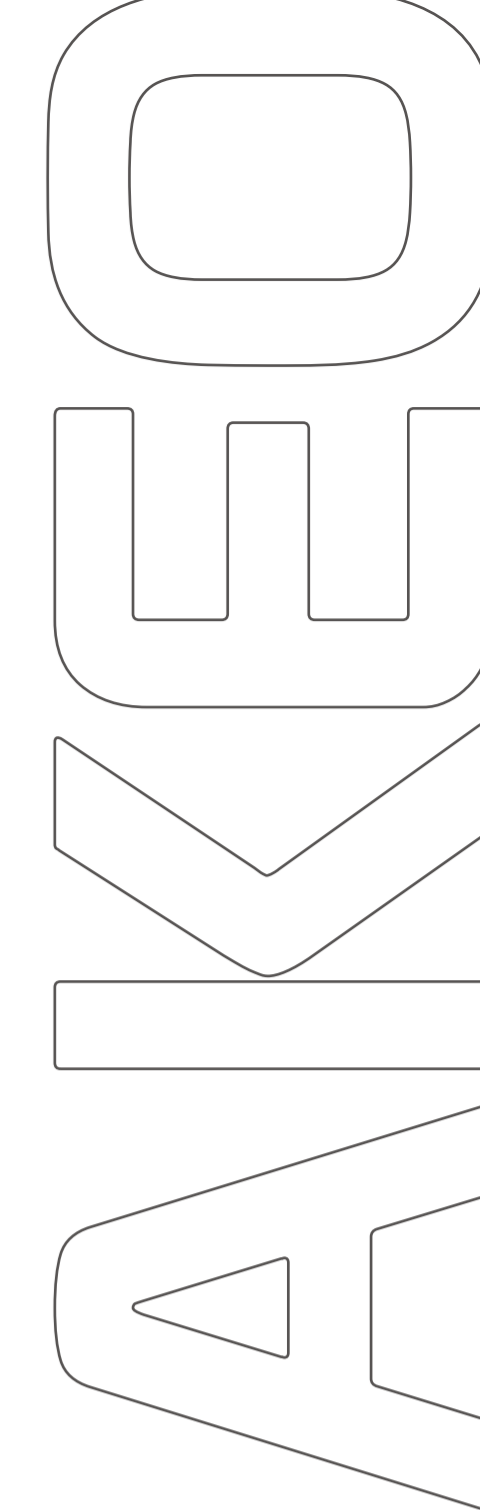

1978 - INÍCIO



1988 - MUDANÇA



1995 - APRIMORAMENTO

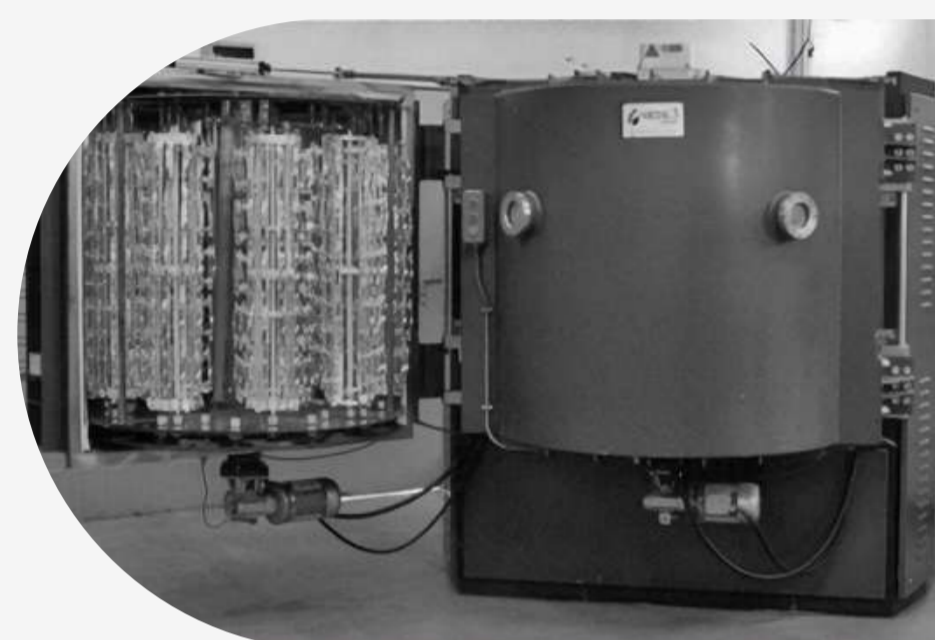

2003 - EVOLUÇÃO



2009 - CRESCIMENTO

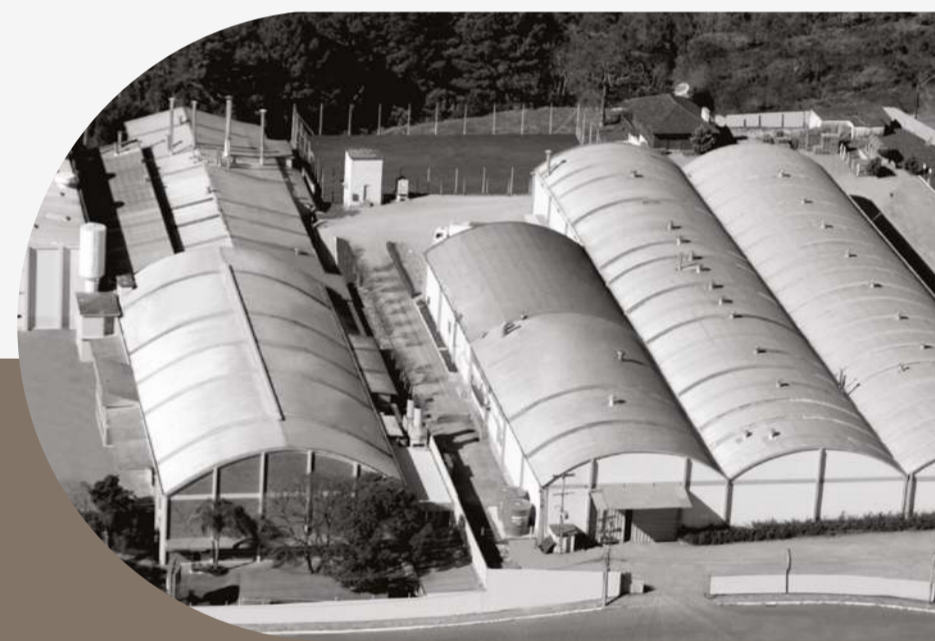

2013 - AMPLIAÇÃO



2024



CONSULTE TAMBÉM NOSSO CATÁLOGO: LINHA PLÁSTICO

PIONEIRISMO,
EXPERIÊNCIA E MUITO
TRABALHO

TORNAM NOSSA
HISTÓRIA ADMIRÁVEL.

TRANSFORMAR IDEIAS
EM SOLUÇÕES QUE INSPIRAM
PESSOAS!

Esse é o nosso propósito. Esse é o
nosso jeito de surpreender você!



ACESSÓRIOS

FITAS DE BORDA

SOLUÇÕES

akeo.com.br

